



PSC

Applications index Anwendungen	E02-05
Dimple lock toolholders Klemmhalter mit Dimple Lock-Klemmung	E06-24
Wedge clamp / Double lock toolholders Klemmhalter mit Pratzen- und Doppel-Klemmung	E25-40
Lever lock toolholders Klemmhalter mit Kniehebel-Klemmung	E41-50
Center screw toolholders Klemmhalter mit Zentralschrauben-Klemmung	E51-65
Antivibratory adaptor Schwingungsgedämpfte Aufnahmen	E66
Dimple lock boring bars Bohrstangen mit Dimple Lock-Klemmung	E67-69
Wedge clamp / Double lock boring bars Bohrstangen mit Pratzen- und Doppel-Klemmung	E70-72
Lever lock boring bars Bohrstangen mit Kniehebel-Klemmung	E73-75
Center screw boring bars Bohrstangen mit Zentralschrauben-Klemmung	E76-82
External and internal threading Außengewindedrehen und Innengewindedrehen	E83-84
Parting and grooving Ab- und Einstechdrehen	E85-91
Drills Bohrer	E92-94
Arbors and adaptors Aufnahmen	E96-125



NEGATIVE TOOLHOLDERS / NEGATIVE KLEMMHALTER

Dimple lock toolholders
Klemmhalter mit Dimple Lock-Klemmung



DCKN 75° CN.. 1204.. CN.. 1606.. CN.. 1906.. Page Seite E06	DCLN 95° Page Seite E07 CN.. 0903.. CN.. 1906..	DCMN 50° Multi-Task Page Seite E08 CN.. 1204.. CN.. 1606..	DCRN 75° CN.. 1204.. CN.. 1606.. CN.. 1906.. Page Seite E09	DDHN 107°30' Page Seite E10 DN.. 1506..
DDJN 93° Page Seite E11 DN.. 1104.. DN.. 1506..	DDMN 48° Multi-Task Page Seite E12 DN.. 1506..	DDNN 63° Page Seite E13 DN.. 1104.. DN.. 1506..	DDUN 93° Page Seite E14 DN.. 1506..	DRSN Page Seite E15 RNMG 1204..
DSDN 45° Page Seite E16 SNM.. 1204.. SNM.. 1506.. SNM.. 1906..	DSKN 75° SNM.. 1204.. SNM.. 1506.. SNM.. 1906.. Page Seite E17	DSRN 75° SNM.. 1204.. SNM.. 1506.. SNM.. 1906.. Page Seite E18	DSSN 45° SNM.. 1204.. SNM.. 1506.. SNM.. 1906.. Page Seite E19	DTFN 90° Page Seite E20 TNM.. 1604.. TNM.. 2204..
DTGN 90° Page Seite E21 TNM.. 1604.. TNM.. 2204..	DVJN 93° Page Seite E22 VN.. 1604..	DVJN 93° Page Seite E23 VN.. 1604..	DVLN 95° Page Seite E24 WNMG 0604.. WNMG 0804..	

Wedge clamp / Double lock toolholders
Klemmhalter mit Pratzen- und Doppel-Klemmung

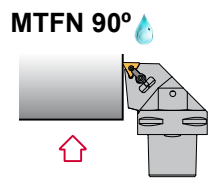
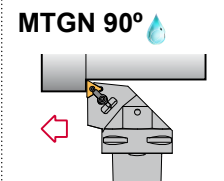
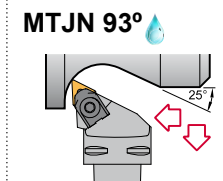
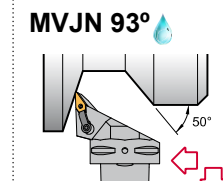
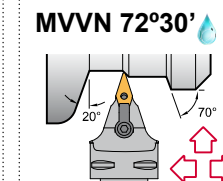
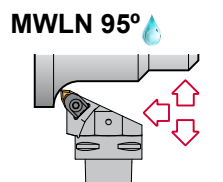
MCKN 75° CN.. 1204.. CN.. 1606.. CN.. 1906.. Page Seite E25	MCLN 95° Page Seite E26 CN.. 0903.. CN.. 1906..	MCRN 75° CN.. 1204.. CN.. 1606.. CN.. 1906.. Page Seite E27	MDJN 93° Page Seite E28 DN.. 1104.. DN.. 1506..	MDNN 63° Page Seite E29 DN.. 1104.. DN.. 1506..
MDUN 93° Page Seite E30 DN.. 1506..	MSDN 45° Page Seite E31 SNM.. 1204.. SNM.. 1506.. SNM.. 1906..	MSKN 75° Page Seite E32 SNM.. 1204.. SNM.. 1506.. SNM.. 1906..	MSRN 75° SNM.. 1204.. SNM.. 1506.. SNM.. 1906.. Page Seite E33	MSSN 45° SNM.. 1204.. SNM.. 1506.. SNM.. 1906.. Page Seite E34

<p>MTFN 90°</p>  <p>Page Seite E35 TNM.. 1604..</p>	<p>MTGN 90°</p>  <p>Page Seite E36 TNM.. 1604..</p>	<p>MTJN 93°</p>  <p>Page Seite E37 TNM.. 1604.. TNM.. 2204..</p>	<p>MVJN 93°</p>  <p>Page Seite E38 VN.. 1604..</p>	<p>MVVN 72°30'</p>  <p>Page Seite E39 VN.. 1604..</p>
<p>MWLN 95°</p>  <p>Page Seite E40 WNMG 0604.. WNMG 0804..</p>				

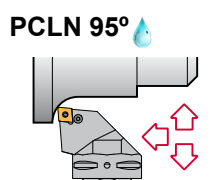
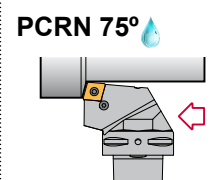
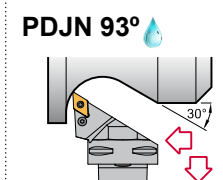
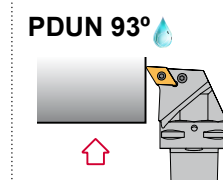
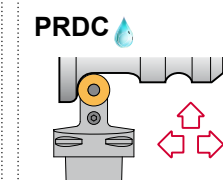
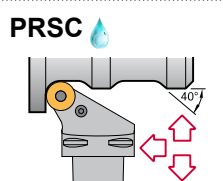
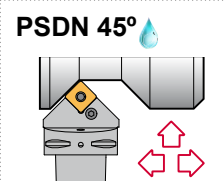
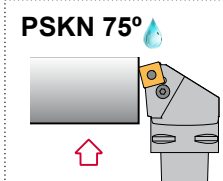
**Lever lock toolholders
Klemmhalter mit Kniehebel-Klemmung**

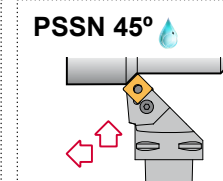
<p>PCLN 95°</p>  <p>Page Seite E41 CN.. 1204.. CN.. 2509..</p>	<p>PCRN 75°</p>  <p>Page Seite E42 CN.. 1204.. CN.. 1606.. CN.. 1906..</p>	<p>PDJN 93°</p>  <p>Page Seite E43 DN.. 1104.. DN.. 1504.. DN.. 1506..</p>	<p>PDUN 93°</p>  <p>Page Seite E44 DN.. 1506..</p>	<p>PRDC</p>  <p>Page Seite E45 RC.. 2507M0 RC.. 3209M0</p>
<p>PRSC</p>  <p>Page Seite E46 RC.. 2006M0 RC.. 2507M0 RC.. 3209M0</p>	<p>PSDN 45°</p>  <p>Page Seite E47 SNM.. 1204.. SNM.. 2507..</p>	<p>PSKN 75°</p>  <p>Page Seite E48 SNM.. 1204.. SNM.. 2507..</p>	<p>PSRN 75°</p>  <p>Page Seite E49 SNM.. 1204.. SNM.. 2507..</p>	<p>PSSN 45°</p>  <p>Page Seite E50 SNM.. 1204.. SNM.. 2507..</p>

POSITIVE TOOLHOLDERS / POSITIVE KLEMMHALTER

**Center screw toolholders
Klemmhalter mit Zentralschrauben-Klemmung**

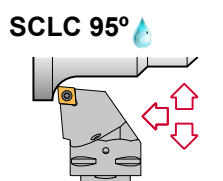
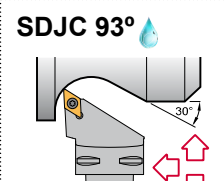
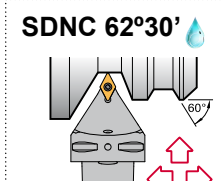
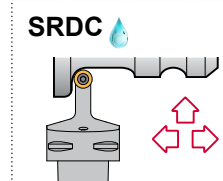
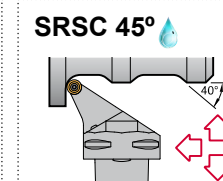
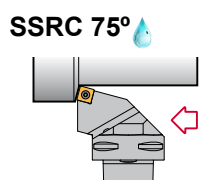
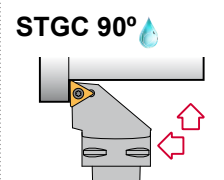
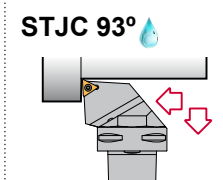
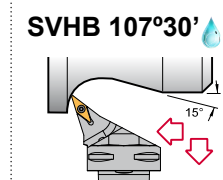
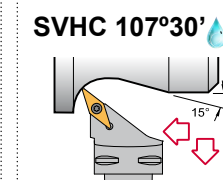
<p>SCLC 95°</p>  <p>Page Seite E51 CC.. 09T3.. CC.. 1204..</p>	<p>SDJC 93°</p>  <p>Page Seite E52 DC.. 0702.. DC.. 11T3..</p>	<p>SDNC 62°30'</p>  <p>Page Seite E53 DC.. 11T3..</p>	<p>SRDC</p>  <p>Page Seite E54 RC.. 0602M0 RC.. 2006M0</p>	<p>SRSC 45°</p>  <p>Page Seite E55 RC.. 0602M0 RC.. 2006M0</p>
<p>SSRC 75°</p>  <p>Page Seite E56 SC.. 1204..</p>	<p>STGC 90°</p>  <p>Page Seite E57 TC.. 1102.. TC.. 16T3..</p>	<p>STJC 93°</p>  <p>Page Seite E58 TC.. 1102.. TC.. 16T3..</p>	<p>SVHB 107°30'</p>  <p>Page Seite E59 VBMT 1604..</p>	<p>SVHC 107°30'</p>  <p>Page Seite E60 VC.. 1103.. VC.. 1604..</p>



POSITIVE TOOLHOLDERS / POSITIVE KLEMMHALTER

SVJB 93°

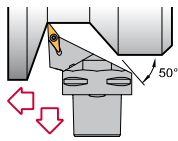

Page
Seite E61 VBMT 1604..

SVJC 93°

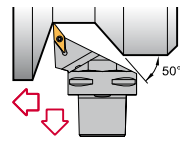

Page
Seite E62 VC.. 1103..
VC.. 1604..

SVMB 50° Multi-Task

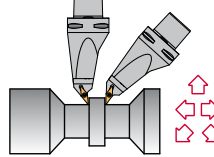

Page
Seite E63 VBMT 1604..

SVVB 72°30'

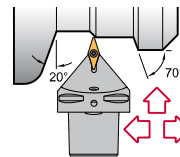

Page
Seite E64 VBMT 1604..

SVVC 72°30'

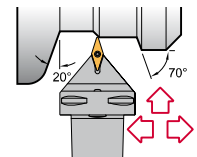

Page
Seite E65 VC.. 1103..
VC.. 1604..

NEGATIVE BORING BARS / NEGATIVE BOHRSTANGEN

Adaptor Adapter

J..



Page
Seite E66

Dimple lock boring bars Bohrstangen mit Dimple Lock-Klemmung

DCLN 95°

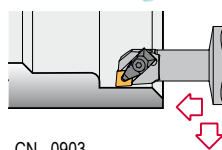

CN.. 0903..
CN.. 1204..
CN.. 1606.. Page
Seite E67

DDUN 93°

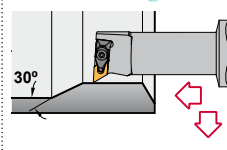

Page
Seite E68 DN.. 1104..
DN.. 1506..

DWLN 95°

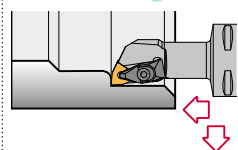

Page
Seite E69 WNMG 0604..
WNMG 0804..

Wedge clamp / Double lock boring bars Bohrstangen mit Prätzen- und Doppel-Klemmung

MTFN 90°

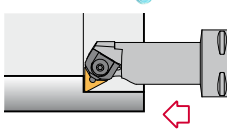

Page
Seite E70 TNM.. 1604..

MVUN 93°

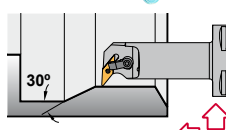

Page
Seite E71 VN.. 1604..

MWLN 95°

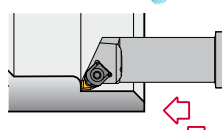

Page
Seite E72 WNMG 0604..
WNMG 0804..

Lever lock boring bars Bohrstangen mit Kniehebel-Klemmung

PCLN 95°

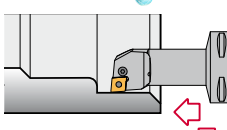

CN.. 0903..
CN.. 1204..
CN.. 1606.. Page
Seite E73

PDUN 93°

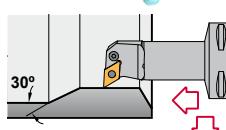

Page
Seite E74 DN.. 1104..
DN.. 1506..

PSKN 75°

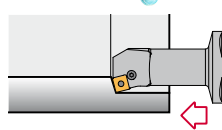

Page
Seite E75 SNM.. 1204..

POSITIVE BORING BARS / POSITIVE BOHRSTANGEN

Center screw boring bars Bohrstangen mit Zentralschrauben-Klemmung

SCLC 95°

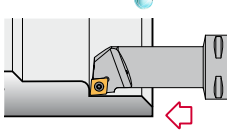

Page
Seite E76 CC.. 09T3..
CC.. 1204..

SDUC 93°

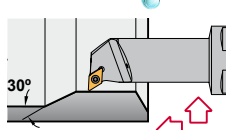

Page
Seite E77 DC.. 0702..
DC.. 11T3..

SDUC-X 93°

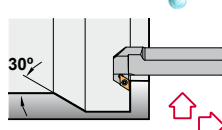

Page
Seite E78 DC.. 0702..

SSKC 75°

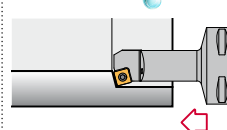

Page
Seite E79 SC.. 09T3..

STFC 90°

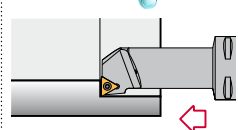

Page
Seite E80 TC.. 1102..
TC.. 16T3..

POSITIVE BORING BARS / POSITIVE BOHRSTANGEN

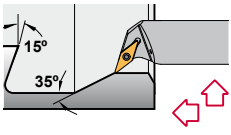
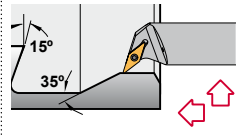
<p>SVQB 107°30'</p>  <p>Page Seite E81</p> <p>VBMT 1604..</p>	<p>SVQC 107°30'</p>  <p>Page Seite E82</p> <p>VC.. 1103.. VC.. 1604..</p>			
---	---	--	--	--

THREADING / GEWINDEDREHEN

External and internal threading Außengewindedrehen und Innengewindedrehen

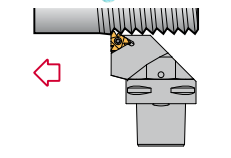
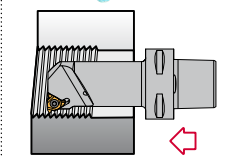
<p>SE 90°</p>  <p>Page Seite E83</p> <p>16 ER/L.. 22 ER/L..</p>	<p>SI 90°</p>  <p>Page Seite E84</p> <p>16 NR/L.. 22 NR/L..</p>			
---	---	--	--	--

PARTING AND GROOVING / AB- UND EINSTECHDREHEN

Toolholders and boring bars Klemmhalter und Bohrstan- gen

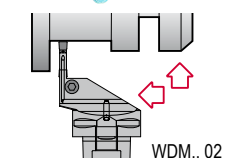
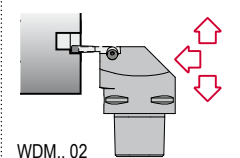
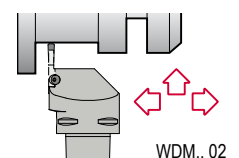
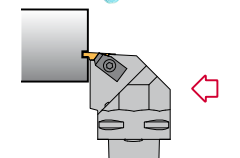
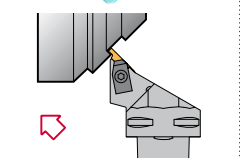
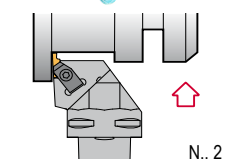
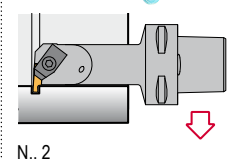
<p>CZCD</p>  <p>Page Seite E85</p> <p>WDM.. 02 .. WDM.. 06</p>	<p>CZFD</p>  <p>WDM.. 02 .. WDM.. 06</p> <p>Page Seite E86</p>	<p>CZGD</p>  <p>Page Seite E87</p> <p>WDM.. 02 .. WDM.. 06</p>	<p>NE 93°</p>  <p>Page Seite E88</p> <p>N.. 3</p>	<p>NR 45°</p>  <p>Page Seite E89</p> <p>N.. 3</p>
<p>NS 93°</p>  <p>Page Seite E90</p> <p>N.. 2 N.. 3 N.. 4</p>	<p>NNT0 93°</p>  <p>N.. 2 N.. 3 N.. 4</p> <p>Page Seite E91</p>			

DRILLS / BOHRER

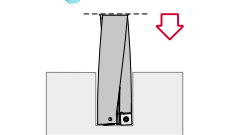
<p>45..</p>  <p>SPMT 0603.. .. SPMT 1204..</p> <p>Page Seite E92-94</p>				
---	--	--	--	--





Characteristics:
Multipurpose toolholder equipped with rhombic negative double-sided insert (angle 80°).
PSC with internal coolant.

- 1) γ = Rake angle (valid with a flat insert).
- 2) λ_s = Angle of inclination.

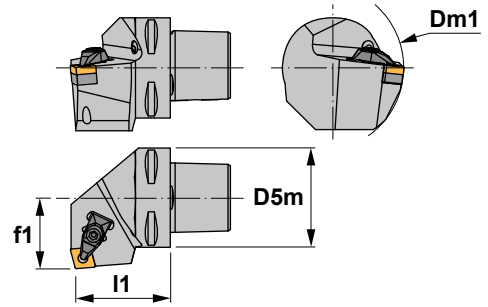

Eigenschaften:
Multifunktions-Werkzeug mit einer doppelseitigen rhombischen negativen Wendschneidplatte (Winkel 80°). PSC mit Innenkühlung.

- 1) γ = Spanwinkel (Gültig nur mit flachen Wendschneidplatte).
- 2) λ_s = Neigungswinkel.

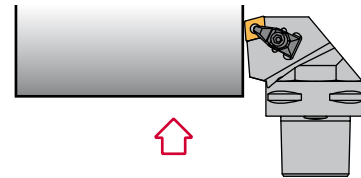

DCKN 75°

Reference Bezeichnung	D5m	Dm1 min.	f1	l1	γ^1	λ_s^2	Insert size Wendschneidplatte	
PSC40-DCKNR/L27050-12	40	110	27	50	-6°	-6°	CN.. 1204..	0,420
PSC50-DCKNR/L35060-12	50	110	35	60	-6°	-6°	CN.. 1204..	0,800
PSC63-DCKNR/L45065-12	63	110	45	65	-6°	-6°	CN.. 1204..	1,100
PSC40-DCKNR/L27050-16	40	125	27	50	-6°	-6°	CN.. 1606..	0,420
PSC50-DCKNR/L35060-16	50	125	35	60	-6°	-6°	CN.. 1606..	0,800
PSC63-DCKNR/L45065-16	63	125	45	65	-6°	-6°	CN.. 1606..	1,100
PSC63-DCKNR/L45065-19	63	125	45	65	-6°	-6°	CN.. 1906..	1,100
PSC80-DCKNR/L55080-19	80	125	55	80	-6°	-6°	CN.. 1906..	2,740

Reference Bezeichnung							Nm
PSC40-DCKNR/L27050-12	1766	ICSN-442	2712	1696	4295	5004	3.5
PSC50-DCKNR/L35060-12	1766	ICSN-442	2712	1696	4295	5004	3.5
PSC63-DCKNR/L45065-12	1766	ICSN-442	2712	1696	4295	5004	3.5
PSC40-DCKNR/L27050-16	1768	ICSN-533	2716	1696	4295	5004	3.5
PSC50-DCKNR/L35060-16	1768	ICSN-533	2716	1696	4295	5004	3.5
PSC63-DCKNR/L45065-16	1768	ICSN-533	2716	1696	4295	5004	3.5
PSC63-DCKNR/L45065-19	1770	ICSN-633	2719	1696	4295	5004	3.5
PSC80-DCKNR/L55080-19	1770	ICSN-633	2719	1696	4295	5004	3.5

CN..

80° rhombic negative inserts.
80° rhombische negative WSP. A32-34

Reference / Bez.	l	s	d
CN.. 1204..	12,90	4,76	12,70
CN.. 1606..	16,10	6,35	15,88
CN.. 1906..	19,30	6,35	19,05

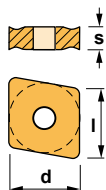



Characteristics:
Multipurpose toolholder equipped with rhombic negative double-sided insert (angle 80°).
PSC with internal coolant.

Eigenschaften:
Multifunktions-Werkzeug mit einer doppelseitigen rhombischen negativen Wendeschneidplatte (Winkel 80°).
PSC mit Innenkühlung.

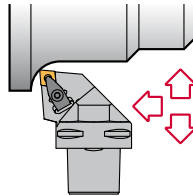
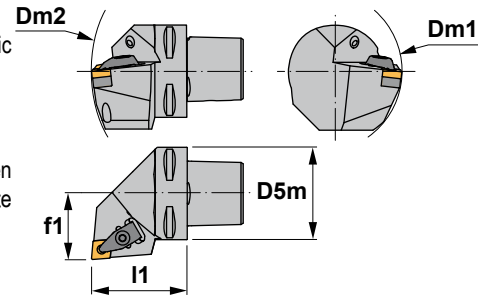

- 1) γ = Rake angle (valid with a flat insert).
Spanwinkel (Gültig nur mit flachen Wendeschneidplatte).
- 2) λ_s = Angle of inclination.
Neigungswinkel.

DCLN 95°

Reference Bezeichnung	D5m	Dm1 min.	Dm2 min.	f1	l1	γ^1	λ_s^2	Insert size Wendeschneidplatte	KG
PSC32-DCLNR/L22040-09	32	60	116	22	40	-6°	-6°	CN.. 0903..	0,210
PSC40-DCLNR/L27050-09	40	60	140	27	50	-6°	-6°	CN.. 0903..	0,420
PSC32-DCLNR/L22045-12	32	60	121	22	45	-6°	-6°	CN.. 1204..	0,240
PSC40-DCLNR/L27050-12	40	110	140	27	50	-6°	-6°	CN.. 1204..	0,420
PSC50-DCLNR/L35060-12	50	110	165	35	60	-6°	-6°	CN.. 1204..	0,800
PSC63-DCLNR/L45065-12	63	110	190	45	65	-6°	-6°	CN.. 1204..	1,100
PSC80-DCLNR/L55080-12	80	110	250	55	80	-6°	-6°	CN.. 1204..	2,740
PSC40-DCLNR/L27055-16	40	125	145	27	55	-6°	-6°	CN.. 1606..	0,430
PSC50-DCLNR/L35060-16	50	125	165	35	60	-6°	-6°	CN.. 1606..	0,800
PSC63-DCLNR/L45065-16	63	125	190	45	65	-6°	-6°	CN.. 1606..	1,100
PSC80-DCLNR/L55080-16	80	125	250	55	80	-6°	-6°	CN.. 1606..	2,740
PSC50-DCLNR/L35060-19	50	125	165	35	60	-6°	-6°	CN.. 1906..	0,800
PSC63-DCLNR/L45065-19	63	125	190	45	65	-6°	-6°	CN.. 1906..	1,100
PSC80-DCLNR/L55080-19	80	125	250	55	80	-6°	-6°	CN.. 1906..	2,740

Reference Bezeichnung							Nm
PSC32-DCLNR/L22040-09	1764	ICSN-332	2708	1695	4294	5004	3.5
PSC40-DCLNR/L27050-09	1764	ICSN-332	2708	1695	4294	5004	3.5
PSC32-DCLNR/L22045-12	1766	ICSN-442	2712	1696	4295	5004	3.5
PSC40-DCLNR/L27050-12	1766	ICSN-442	2712	1696	4295	5004	3.5
PSC50-DCLNR/L35060-12	1766	ICSN-442	2712	1696	4295	5004	3.5
PSC63-DCLNR/L45065-12	1766	ICSN-442	2712	1696	4295	5004	3.5
PSC80-DCLNR/L55080-12	1766	ICSN-442	2712	1696	4295	5004	3.5
PSC40-DCLNR/L27055-16	1768	ICSN-533	2716	1696	4295	5004	3.5
PSC50-DCLNR/L35060-16	1768	ICSN-533	2716	1696	4295	5004	3.5
PSC63-DCLNR/L45065-16	1768	ICSN-533	2716	1696	4295	5004	3.5
PSC80-DCLNR/L55080-16	1768	ICSN-533	2716	1696	4295	5004	3.5
PSC50-DCLNR/L35060-19	1770	ICSN-633	2719	1696	4295	5004	3.5
PSC63-DCLNR/L45065-19	1770	ICSN-633	2719	1696	4295	5004	3.5
PSC80-DCLNR/L55080-19	1770	ICSN-633	2719	1696	4295	5004	3.5

CN.. 80° rhombic negative inserts. 80° rhombische negative WSP. A32-34

Reference / Bez.	l	s	d
CN.. 0903..	9,65	3,18	9,52
CN.. 1204..	12,90	4,76	12,70
CN.. 1606..	16,10	6,35	15,88
CN.. 1906..	19,30	6,35	19,05

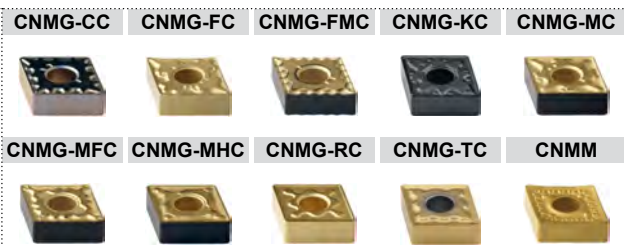
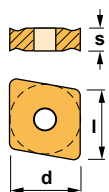



Characteristics:
Toolholder for multi-task machining equipped with rhombic negative inserts (angle 80°).
PSC with internal coolant.

- 1) γ = Rake angle (valid with a flat insert).
- 2) λ_s = Angle of inclination.

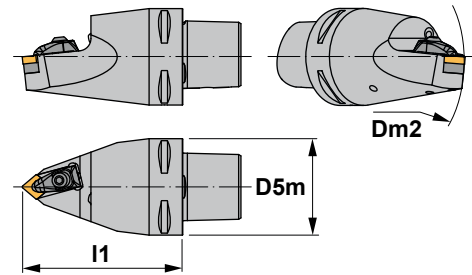

Eigenschaften:
Klemmhalter zur Multi-Task-Bearbeitung mit einer doppelseitigen rhombischen negativen Wendschneidplatte (80° Winkel).
PSC mit Innenkühlung.

- 1) γ = Spanwinkel (Gültig nur mit flachen Wendschneidplatte).
- 2) λ_s = Neigungswinkel.

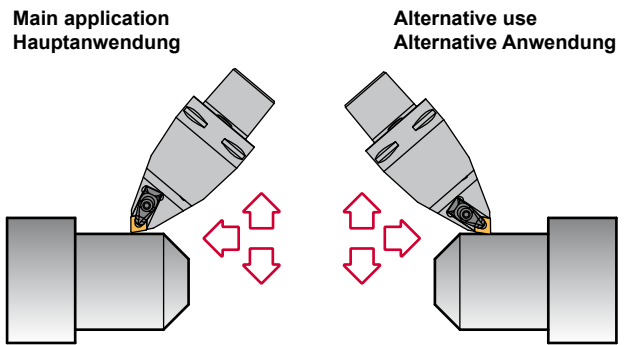

DCMN 50°

Reference Bezeichnung	D5m	Dm2 min.	l1	γ^1	λ_s^2	Insert size Wendschneidplatte	Kg
PSC63-DCMNN00115-12	63	110	115	-6°	-6°	CN.. 1204..	1,700
PSC80-DCMNN00150-16	80	115	150	-6°	-6°	CN.. 1606..	3,300

Reference Bezeichnung							Nm
PSC63-DCMNN00115-12	1766	ICSN-442	2712	1696	4295	5004	3.5
PSC80-DCMNN00150-16	1768	ICSN-533	2716	1696	4295	5004	3.5

CN.. 80° rhombic negative inserts.
80° rhombische negative WSP. A32-34

Reference / Bez.	l	s	d
CN.. 1204..	12,90	4,76	12,70
CN.. 1606..	16,10	6,35	15,88

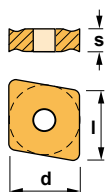



Characteristics:
Multipurpose toolholder equipped with rhombic negative double-sided insert (angle 80°).
PSC with internal coolant.

- 1) γ = Rake angle (valid with a flat insert).
- 2) λ_s = Angle of inclination.

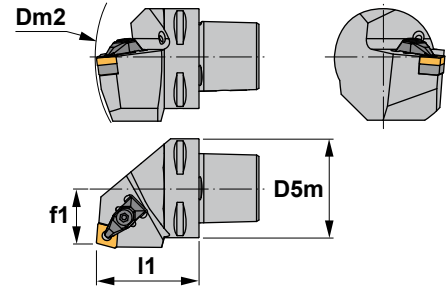

Eigenschaften:
Multifunktions-Werkzeug mit einer doppelseitigen rhombischen negativen Wendeschneidplatte (Winkel 80°).
PSC mit Innenkühlung.

- 1) γ = Spanwinkel (Gültig nur mit flachen Wendeschneidplatte).
- 2) λ_s = Neigungswinkel.

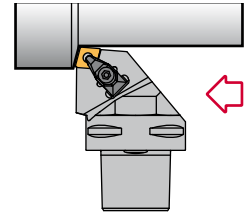

DCRN 75°

Reference Bezeichnung	D5m	Dm2 min.	f1	l1	$\gamma^{1)}$	$\lambda_{s2)}$	Insert size Wendeschneidplatte	Kg
PSC40-DCRNR/L22050-12	40	140	22	50	-6°	-6°	CN.. 1204..	0,420
PSC50-DCRNR/L27060-12	50	165	27	60	-6°	-6°	CN.. 1204..	0,800
PSC63-DCRNR/L35065-12	63	190	35	65	-6°	-6°	CN.. 1204..	1,400
PSC50-DCRNR/L27060-16	50	165	27	60	-6°	-6°	CN.. 1606..	0,800
PSC63-DCRNR/L35065-16	63	190	35	65	-6°	-6°	CN.. 1606..	1,400
PSC80-DCRNR/L55080-16	80	250	55	80	-6°	-6°	CN.. 1606..	2,740
PSC50-DCRNR/L27060-19	50	165	27	60	-6°	-6°	CN.. 1906..	0,800
PSC63-DCRNR/L35065-19	63	190	35	65	-6°	-6°	CN.. 1906..	1,400
PSC80-DCRNR/L55080-19	80	250	55	80	-6°	-6°	CN.. 1906..	2,740

Reference Bezeichnung							Nm
PSC40-DCRNR/L22050-12	1766	ICSN-442	2712	1696	4295	5004	3.5
PSC50-DCRNR/L27060-12	1766	ICSN-442	2712	1696	4295	5004	3.5
PSC63-DCRNR/L35065-12	1766	ICSN-442	2712	1696	4295	5004	3.5
PSC50-DCRNR/L27060-16	1768	ICSN-533	2716	1696	4295	5004	3.5
PSC63-DCRNR/L35065-16	1768	ICSN-533	2716	1696	4295	5004	3.5
PSC80-DCRNR/L55080-16	1768	ICSN-533	2716	1696	4295	5004	3.5
PSC50-DCRNR/L27060-19	1770	ICSN-633	2719	1696	4295	5004	3.5
PSC63-DCRNR/L35065-19	1770	ICSN-633	2719	1696	4295	5004	3.5
PSC80-DCRNR/L55080-19	1770	ICSN-633	2719	1696	4295	5004	3.5

CN.. 80° rhombic negative inserts. 80° rhombische negative WSP. A32-34

Reference / Bez.	l	s	d
CN.. 1204..	12,90	4,76	12,70
CN.. 1606..	16,10	6,35	15,88
CN.. 1906..	19,30	6,35	19,05

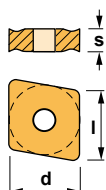



Characteristics:
Turning and profiling toolholder equipped with rhombic negative double-sided insert (angle 55°).
PSC with internal coolant.

- 1) γ = Rake angle (valid with a flat insert).
- 2) λ_s = Angle of inclination.

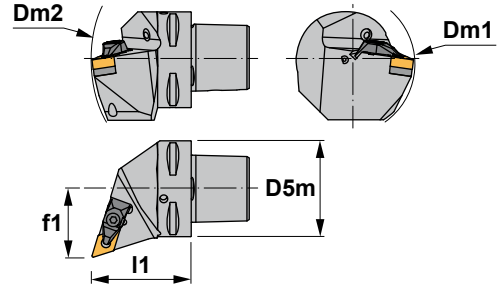

Eigenschaften:
Klemmhalter zum Drehen und Kopierdrehen mit einer doppelseitigen rhombischen negativen Wendeschneiplatte (Winkel 55°).
PSC mit Innenkühlung.

- 1) γ = Spanwinkel (Gültig nur mit flachen Wendeschneidplatte).
- 2) λ_s = Neigungswinkel.

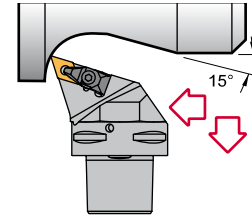

DDHN 107° 30'

Reference Bezeichnung	D5m	Dm1 min.	Dm2 min.	f1	l1	γ^1	λ_s^2	Insert size Wendeschneidplatte	
PSC40-DDHNR/L27055-15	40	110	145	27	55	-6°	-7°	DN.. 1506..	0,430
PSC50-DDHNR/L35060-15	50	110	165	35	60	-6°	-7°	DN.. 1506..	0,800
PSC63-DDHNR/L45065-15	63	110	190	45	65	-6°	-7°	DN.. 1506..	1,100
PSC80-DDHNR/L55080-15	80	110	250	55	80	-6°	-7°	DN.. 1506..	2,740

Reference Bezeichnung							Nm
PSC40-DDHNR/L27055-15	1766	IDSN-432	2712	1696	4295	5004	3.5
PSC50-DDHNR/L35060-15	1766	IDSN-432	2712	1696	4295	5004	3.5
PSC63-DDHNR/L45065-15	1766	IDSN-432	2712	1696	4295	5004	3.5
PSC80-DDHNR/L55080-15	1766	IDSN-432	2712	1696	4295	5004	3.5

DN.. 55° rhombic negative inserts. A36-37
55° rhombische negative Wendeschneidplatten.

Reference / Bez.	l	s	d
DN.. 1506..	15,50	6,35	12,70

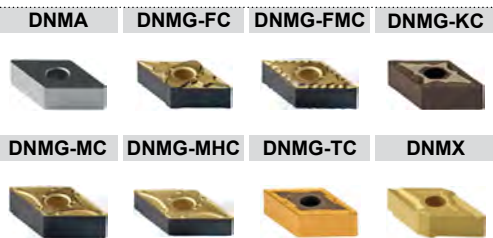
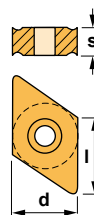



Characteristics:
Turning and profiling toolholder equipped with rhombic negative double-sided insert (angle 55°).
PSC with internal coolant.

- 1) γ = Rake angle (valid with a flat insert).
- 2) λ_s = Angle of inclination.

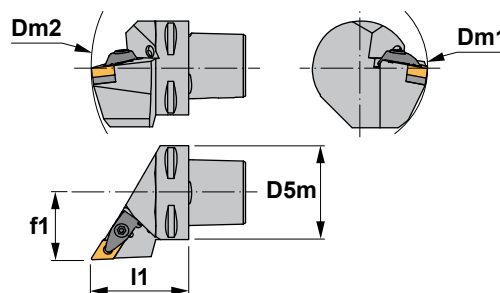

Eigenschaften:
Klemmhalter zum Drehen und Kopierdrehen mit einer doppelseitigen rhombischen negativen Wendeschneidplatte (Winkel 55°).
PSC mit Innenkühlung.

- 1) γ = Spanwinkel (Gültig nur mit flachen Wendeschneidplatte).
- 2) λ_s = Neigungswinkel.

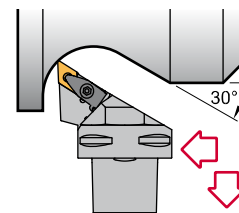

DDJN 93°

Reference Bezeichnung	D5m	Dm1 min.	Dm2 min.	f1	l1	$\gamma^1)$	$\lambda_s^2)$	Insert size Wendeschneidplatte	Kg
PSC32-DDJNR/L22045-11	32	60	121	22	45	-6°	-7°	DN.. 1104..	0,240
PSC40-DDJNR/L27050-11	40	60	140	27	50	-6°	-7°	DN.. 1104..	0,420
PSC50-DDJNR/L35060-11	50	65	165	35	60	-6°	-7°	DN.. 1104..	0,800
PSC63-DDJNR/L45065-11	63	81	190	45	65	-6°	-7°	DN.. 1104..	1,100
PSC40-DDJNR/L27055-15	40	110	145	27	55	-6°	-7°	DN.. 1506..	0,420
PSC50-DDJNR/L35060-15	50	110	165	35	60	-6°	-7°	DN.. 1506..	0,800
PSC63-DDJNR/L45065-15	63	110	190	45	65	-6°	-7°	DN.. 1506..	1,100
PSC80-DDJNR/L55080-15	80	110	250	55	80	-6°	-7°	DN.. 1506..	2,740

Reference Bezeichnung							Nm
PSC32-DDJNR/L22045-11	1764	IDSN-322	2708	1695	4294	5004	3.5
PSC40-DDJNR/L27050-11	1764	IDSN-322	2708	1695	4294	5004	3.5
PSC50-DDJNR/L35060-11	1764	IDSN-322	2708	1695	4294	5004	3.5
PSC63-DDJNR/L45065-11	1764	IDSN-322	2708	1695	4294	5004	3.5
PSC40-DDJNR/L27055-15	1766	IDSN-432	2712	1696	4295	5004	3.5
PSC50-DDJNR/L35060-15	1766	IDSN-432	2712	1696	4295	5004	3.5
PSC63-DDJNR/L45065-15	1766	IDSN-432	2712	1696	4295	5004	3.5
PSC80-DDJNR/L55080-15	1766	IDSN-432	2712	1696	4295	5004	3.5

DN.. 55° rhombic negative inserts. A36-37
55° rhombische negative Wendeschneidplatten.

Reference / Bez.	l	s	d
DN.. 1104..	11,60	4,76	9,52
DN.. 1506..	15,50	6,35	12,70

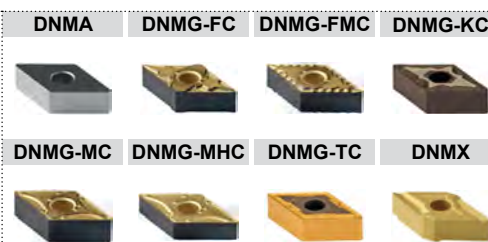
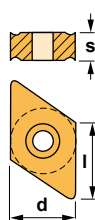



Characteristics:
Toolholder for multi-task machining equipped with rhombic negative inserts (angle 55°).
PSC with internal coolant.

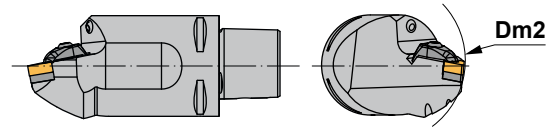

- 1) γ = Rake angle (valid with a flat insert).
- 2) λ_s = Angle of inclination.

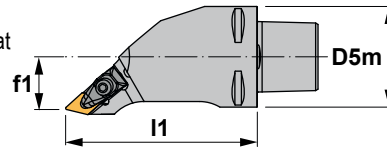

Eigenschaften:
Klemmhalter zur Multi-Task-Bearbeitung mit einer doppelseitigen rhombischen negativen Wendschneidplatte (55° Winkel).
PSC mit Innenkühlung.

- 1) γ = Spanwinkel (Gültig nur mit flachen Wendschneidplatte).
- 2) λ_s = Neigungswinkel.

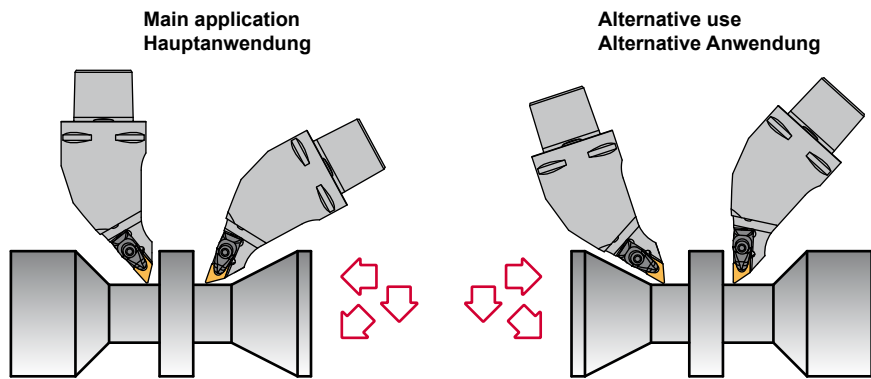

DDMN 48°

Reference Bezeichnung	D5m	Dm2 min.	f1	l1	γ_1	λ_{s2}	Insert size Wendschneidplatte	
PSC63-DDMNR/L33120-15	63	130	33	120	-5°	-9°	DN.. 1506..	2,300

Reference Bezeichnung							Nm
PSC63-DDMNR/L33120-15	1766	IDSN-432	2712	1696	4295	5004	3.5

DN..	55° rhombic negative inserts. A36-37 55° rhombische negative Wendschneidplatten.		
Reference / Bez.	l	s	d
DN.. 1506..	15,50	6,35	12,70

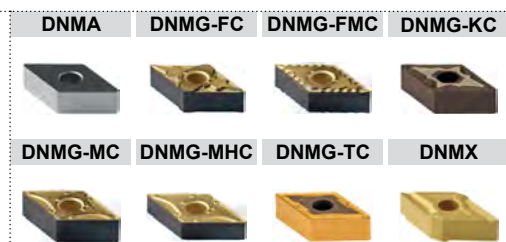
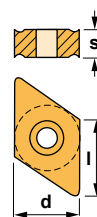



Characteristics:
Profiling toolholder equipped with rhombic negative double-sided insert (angle 55°).
PSC with internal coolant.

- 1) γ = Rake angle (valid with a flat insert).
- 2) λ_s = Angle of inclination.

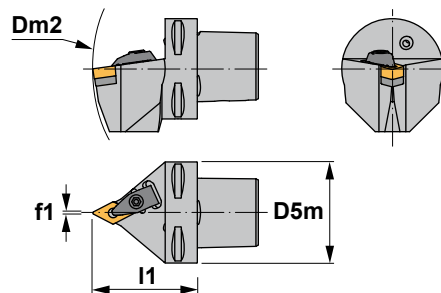

Eigenschaften:
Klemmhalter zum Profildrehen mit einer doppelseitigen rhombischen negativen Wendeschneidplatte (Winkel 55°).
PSC mit Innenkühlung.

- 1) γ = Spanwinkel (Gültig nur mit flachen Wendeschneidplatte).
- 2) λ_s = Neigungswinkel.

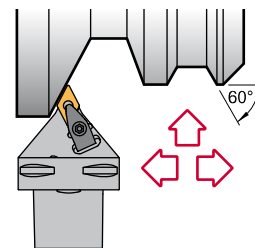

DDNN 63°

Reference Bezeichnung	D5m	Dm2 min.	f1	l1	γ^1	λ_s^2	Insert size Wendeschneidplatte	Kg
PSC40-DDNNN00050-11	40	140	0.5	50	-5°	-9°	DN.. 1104..	0,350
PSC50-DDNNN00060-11	50	165	0.5	60	-5°	-9°	DN.. 1104..	0,750
PSC40-DDNNN00055-15	40	145	0.5	55	-5°	-9°	DN.. 1506..	0,350
PSC50-DDNNN00060-15	50	165	0.5	60	-5°	-9°	DN.. 1506..	0,750
PSC63-DDNNN00065-15	63	190	0.5	65	-5°	-9°	DN.. 1506..	1,070
PSC80-DDNNN00080-15	80	250	0.5	80	-5°	-9°	DN.. 1506..	2,320

Reference Bezeichnung							Nm
PSC40-DDNNN00050-11	1764	IDSN-322	2708	1695	4294	5004	3.5
PSC50-DDNNN00060-11	1764	IDSN-322	2708	1695	4294	5004	3.5
PSC40-DDNNN00055-15	1766	IDSN-432	2712	1696	4295	5004	3.5
PSC50-DDNNN00060-15	1766	IDSN-432	2712	1696	4295	5004	3.5
PSC63-DDNNN00065-15	1766	IDSN-432	2712	1696	4295	5004	3.5
PSC80-DDNNN00080-15	1766	IDSN-432	2712	1696	4295	5004	3.5

DN.. 55° rhombic negative inserts. A36-37
55° rhombische negative Wendeschneidplatten.

Reference / Bez.	l	s	d
DN.. 1104..	11,60	4,76	9,52
DN.. 1506..	15,50	6,35	12,70

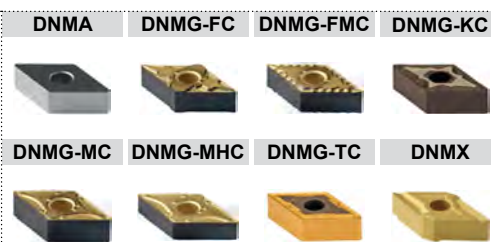
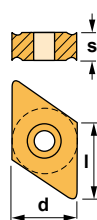



Characteristics:
Turning and profiling toolholder equipped with rhombic negative double-sided insert (angle 55°).
PSC with internal coolant.

- 1) γ = Rake angle (valid with a flat insert).
- 2) λ_s = Angle of inclination.

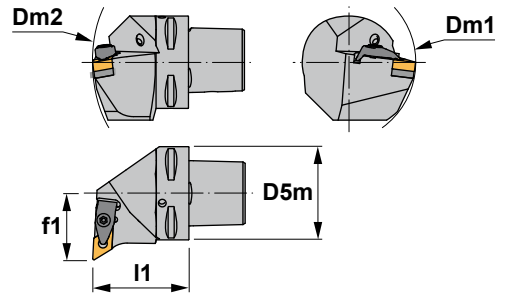

Eigenschaften:
Klemmhalter zum Drehen und Kopierdrehen mit einer doppelseitigen rhombischen negativen Wendeschneidplatte (Winkel 55°).
PSC mit Innenkühlung.

- 1) γ = Spanwinkel (Gültig nur mit flachen Wendeschneidplatte).
- 2) λ_s = Neigungswinkel.

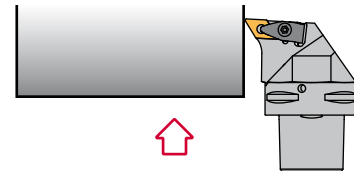

DDUN 93°

Reference Bezeichnung	D5m	Dm1 min.	Dm2 min.	f1	l1	γ^1	λ_s^2	Insert size Wendeschneidplatte	Kg
PSC40-DDUNR/L27050-15	40	110	140	27	50	-6°	-7°	DN.. 1506..	0,420
PSC50-DDUNR/L35060-15	50	110	165	35	60	-6°	-7°	DN.. 1506..	0,800
PSC63-DDUNR/L45065-15	63	110	190	45	65	-6°	-7°	DN.. 1506..	1,100
PSC80-DDUNR/L55080-15	80	110	250	55	80	-6°	-7°	DN.. 1506..	2,740

Reference Bezeichnung							Nm
PSC40-DDUNR/L27050-15	1766	IDSN-432	2712	1696	4295	5004	3.5
PSC50-DDUNR/L35060-15	1766	IDSN-432	2712	1696	4295	5004	3.5
PSC63-DDUNR/L45065-15	1766	IDSN-432	2712	1696	4295	5004	3.5
PSC80-DDUNR/L55080-15	1766	IDSN-432	2712	1696	4295	5004	3.5

DN.. 55° rhombic negative inserts. A36-37
55° rhombische negative Wendeschneidplatten.

Reference / Bez.	l	s	d
DN.. 1506..	15,50	6,35	12,70

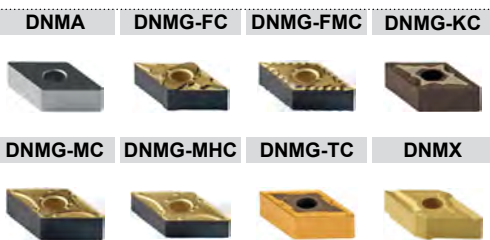
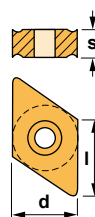



Characteristics:
Profiling multipurpose turning toolholder equipped with round negative insert. PSC with internal coolant.

- 1) γ = Rake angle (valid with a flat insert).
- 2) λ_s = Angle of inclination.

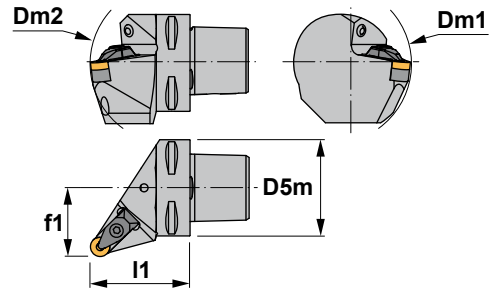

Eigenschaften:
Multifunktions-Klemmhalter zum Profildrehen mit einer runden negativen Wendeschneidplatte. PSC mit Innenkühlung.

- 1) γ = Spanwinkel (Gültig nur mit flachen Wendeschneidplatte).
- 2) λ_s = Neigungswinkel.

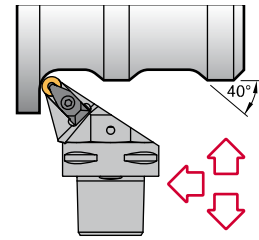

DRSN

Reference Bezeichnung	D5m	Dm1 min.	Dm2 min.	f1	l1	γ^1	λ_s^2	Insert size Wendeschneidplatte	Kg
PSC40-DRSNR/L27050-12	40	110	140	27	50	-6°	-6°	RNMG 1204..	0,420
PSC50-DRSNR/L35060-12	50	110	165	35	60	-6°	-6°	RNMG 1204..	0,800
PSC63-DRSNR/L45065-12	63	110	190	45	65	-6°	-6°	RNMG 1204..	1,100

Reference Bezeichnung							Nm
PSC40-DRSNR/L27050-12	1766	IRSN-44	2712	1696	4295	5004	3.5
PSC50-DRSNR/L35060-12	1766	IRSN-44	2712	1696	4295	5004	3.5
PSC63-DRSNR/L45065-12	1766	IRSN-44	2712	1696	4295	5004	3.5

RNMG

Round negative insert.
Runde negative Wendeschneidplatte. A39

Reference / Bez.	s	d
RNMG 1204..	4,76	12,70

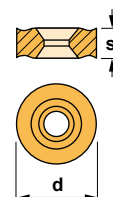

RNMG





Characteristics:

Toolholder for external turning and chamfering applications equipped with square negative inserts.
PSC with internal coolant.

- 1) γ = Rake angle (valid with a flat insert).
- 2) λ_s = Angle of inclination.

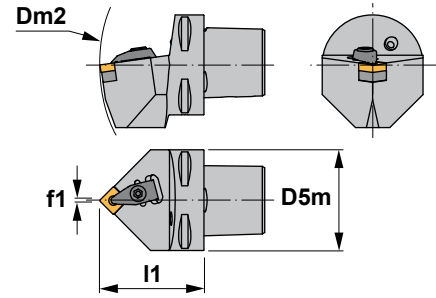

Eigenschaften:

Klemmhalter zum Außendrehen und Abschrägen mit einer vierkantigen negativen Wendeschneidplatte.
PSC mit Innenkühlung.

- 1) γ = Spanwinkel (Gültig nur mit flachen Wendeschneidplatte).
- 2) λ_s = Neigungswinkel.

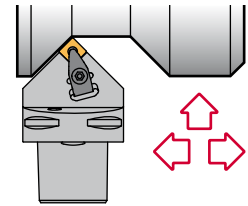

DSDN 45°

Reference Bezeichnung	D5m	Dm2 min.	f1	l1	$\gamma^1)$	$\lambda_s^2)$	Insert size Wendeschneidplatte	kg
PSC32-DSDNN00048-12	32	124	0.3	48	-6°	-6°	SNM.. 1204..	0,240
PSC40-DSDNN00050-12	40	140	0.3	50	-6°	-6°	SNM.. 1204..	0,350
PSC50-DSDNN00060-12	50	165	0.3	60	-6°	-6°	SNM.. 1204..	0,750
PSC63-DSDNN00065-12	63	190	0.3	65	-6°	-6°	SNM.. 1204..	1,070
PSC50-DSDNN00060-15	50	165	0.5	60	-6°	-6°	SNM.. 1506..	0,750
PSC63-DSDNN00065-15	63	190	0.5	65	-6°	-6°	SNM.. 1506..	1,070
PSC50-DSDNN00065-19	50	170	0.5	65	-6°	-6°	SNM.. 1906..	0,800
PSC63-DSDNN00070-19	63	195	0.5	70	-6°	-6°	SNM.. 1906..	1,260

Reference Bezeichnung							Nm
PSC32-DSDNN00048-12	1766	ISSN-442	2712	1696	4295	5004	3.5
PSC40-DSDNN00050-12	1766	ISSN-442	2712	1696	4295	5004	3.5
PSC50-DSDNN00060-12	1766	ISSN-442	2712	1696	4295	5004	3.5
PSC63-DSDNN00065-12	1766	ISSN-442	2712	1696	4295	5004	3.5
PSC50-DSDNN00060-15	1768	ISSN-533	2716	1696	4295	5004	3.5
PSC63-DSDNN00065-15	1768	ISSN-533	2716	1696	4295	5004	3.5
PSC50-DSDNN00065-19	1770	ISSN-633	2719	1696	4295	5004	3.5
PSC63-DSDNN00070-19	1770	ISSN-633	2719	1696	4295	5004	3.5

SNM..

Square negative inserts.
Vierkantige negative Wendeschneidplatten. A41-42

Reference / Bez.	l	s	d
SNM.. 1204..	12,70	4,76	12,70
SNM.. 1506..	15,88	6,35	15,88
SNM.. 1906..	19,05	6,35	19,05

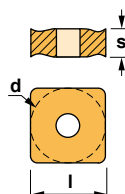

SNMG-FMC



SNMG-KC



SNMG-MHC



SNMG-RC



SNMG-TC



SNMM





Characteristics:

Toolholder for face turning applications equipped with square negative inserts. PSC with internal coolant.

- 1) γ = Rake angle (valid with a flat insert).
- 2) λ_s = Angle of inclination.

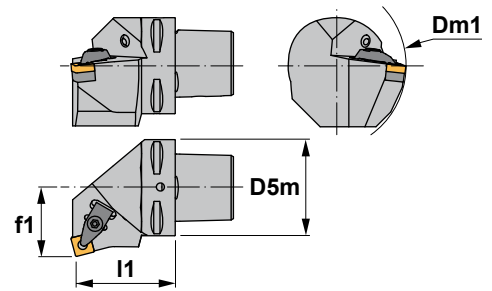

Eigenschaften:

Klemmhalter zum Plandrehen mit einer vierkantigen negativen Wendeschneidplatte. PSC mit Innenkühlung.

- 1) γ = Spanwinkel (Gültig nur mit flachen Wendeschneidplatte).
- 2) λ_s = Neigungswinkel.

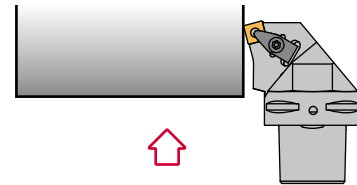

DSKN 75°

Reference Bezeichnung	D5m	Dm1 min.	f1	l1	$\gamma^1)$	$\lambda_s^2)$	Insert size Wendeschneidplatte	
PSC32-DSKNR/L22040-12	32	60	22	40	-6°	-6°	SNM.. 1204..	0,210
PSC40-DSKNR/L27050-12	40	110	27	50	-6°	-6°	SNM.. 1204..	0,420
PSC50-DSKNR/L35060-12	50	110	35	60	-6°	-6°	SNM.. 1204..	0,800
PSC63-DSKNR/L45065-12	63	110	45	65	-6°	-6°	SNM.. 1204..	1,100
PSC50-DSKNR/L35060-15	50	125	35	60	-6°	-6°	SNM.. 1506..	0,800
PSC63-DSKNR/L45065-15	63	125	45	65	-6°	-6°	SNM.. 1506..	1,100
PSC50-DSKNR/L35060-19	50	125	35	60	-6°	-6°	SNM.. 1906..	0,800
PSC63-DSKNR/L45065-19	63	125	45	65	-6°	-6°	SNM.. 1906..	1,100
PSC80-DSKNR/L55080-19	80	125	55	80	-6°	-6°	SNM.. 1906..	2,740

Reference Bezeichnung							Nm
PSC32-DSKNR/L22040-12	1766	ISSN-442	2712	1696	4295	5004	3.5
PSC40-DSKNR/L27050-12	1766	ISSN-442	2712	1696	4295	5004	3.5
PSC50-DSKNR/L35060-12	1766	ISSN-442	2712	1696	4295	5004	3.5
PSC63-DSKNR/L45065-12	1766	ISSN-442	2712	1696	4295	5004	3.5
PSC50-DSKNR/L35060-15	1768	ISSN-533	2716	1696	4295	5004	3.5
PSC63-DSKNR/L45065-15	1768	ISSN-533	2716	1696	4295	5004	3.5
PSC50-DSKNR/L35060-19	1770	ISSN-633	2719	1696	4295	5004	3.5
PSC63-DSKNR/L45065-19	1770	ISSN-633	2719	1696	4295	5004	3.5
PSC80-DSKNR/L55080-19	1770	ISSN-633	2719	1696	4295	5004	3.5

SNM.. Square negative inserts. Vierkantige negative Wendeschneidplatten. A41-42

Reference / Bez.	l	s	d
SNM.. 1204..	12,70	4,76	12,70
SNM.. 1506..	15,88	6,35	15,88
SNM.. 1906..	19,05	6,35	19,05

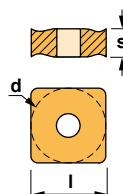

SNMG-FMC	SNMG-KC	SNMG-MHC
SNMG-RC	SNMG-TC	SNMM



**Characteristics:**

Toolholder for face turning applications equipped with square negative inserts. PSC with internal coolant.

- 1) γ = Rake angle (valid with a flat insert).
- 2) λ_s = Angle of inclination.

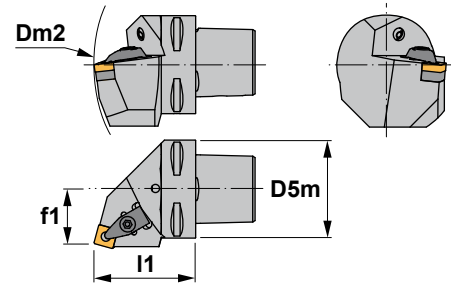
**Eigenschaften:**

Klemhalter zum Plandrehen mit einer vierkantigen negativen Wendeschneidplatte. PSC mit Innenkühlung.

- 1) γ = Spanwinkel (Gültig nur mit flachen Wendeschneidplatte).
- 2) λ_s = Neigungswinkel.

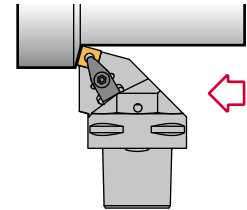

DSRN 75°

Reference Bezeichnung	D5m	Dm2 min.	f1	I1	γ^1	λ_s^2	Insert size Wendeschneidplatte	KG
PSC32-DSRNR/L19048-12	32	124	19	48	-6°	-6°	SNM.. 1204..	0,260
PSC40-DSRNR/L22050-12	40	140	22	50	-6°	-6°	SNM.. 1204..	0,420
PSC50-DSRNR/L27060-12	50	165	27	60	-6°	-6°	SNM.. 1204..	0,800
PSC63-DSRNR/L35065-12	63	190	35	65	-6°	-6°	SNM.. 1204..	1,400
PSC50-DSRNR/L27060-15	50	165	27	60	-6°	-6°	SNM.. 1506..	0,800
PSC63-DSRNR/L35065-15	63	190	35	65	-6°	-6°	SNM.. 1506..	1,400
PSC50-DSRNR/L27060-19	50	165	27	60	-6°	-6°	SNM.. 1906..	0,800
PSC63-DSRNR/L35065-19	63	190	35	65	-6°	-6°	SNM.. 1906..	1,400
PSC80-DSRNR/L45080-19	80	250	45	80	-6°	-6°	SNM.. 1906..	2,800

Reference Bezeichnung							Nm
PSC32-DSRNR/L19048-12	1766	ISSN-442	2712	1696	4295	5004	3.5
PSC40-DSRNR/L22050-12	1766	ISSN-442	2712	1696	4295	5004	3.5
PSC50-DSRNR/L27060-12	1766	ISSN-442	2712	1696	4295	5004	3.5
PSC63-DSRNR/L35065-12	1766	ISSN-442	2712	1696	4295	5004	3.5
PSC50-DSRNR/L27060-15	1768	ISSN-533	2716	1696	4295	5004	3.5
PSC63-DSRNR/L35065-15	1768	ISSN-533	2716	1696	4295	5004	3.5
PSC50-DSRNR/L27060-19	1770	ISSN-633	2719	1696	4295	5004	3.5
PSC63-DSRNR/L35065-19	1770	ISSN-633	2719	1696	4295	5004	3.5
PSC80-DSRNR/L45080-19	1770	ISSN-633	2719	1696	4295	5004	3.5

SNM..

Square negative inserts.
Vierkantige negative Wendeschneidplatten. A41-42

Reference / Bez.	l	s	d
SNM.. 1204..	12,70	4,76	12,70
SNM.. 1506..	15,88	6,35	15,88
SNM.. 1906..	19,05	6,35	19,05

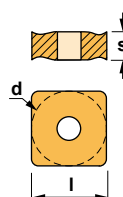
**SNMG-FMC****SNMG-KC****SNMG-MHC****SNMG-RC****SNMG-TC****SNMM**



Characteristics:

Toolholder for external turning and chamfering applications equipped with square negative inserts.
PSC with internal coolant.

- 1) γ = Rake angle (valid with a flat insert).
- 2) λ_s = Angle of inclination.

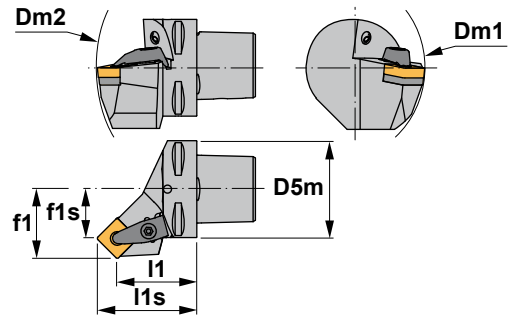

Eigenschaften:

Klemmhalter zum Außendrehen und Abschrägen mit einer vierkantigen negativen Wendeschneidplatte.
PSC mit Innenkühlung.

- 1) γ = Spanwinkel (Gültig nur mit flachen Wendeschneidplatte).
- 2) λ_s = Neigungswinkel.

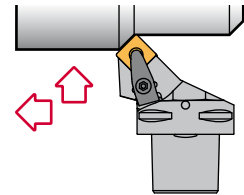

DSSN 45°

Reference Bezeichnung	D5m	Dm1 min.	Dm2 min.	f1	f1s	l1	l1s	γ^1	λ_s^2	Insert size Wendeschneidplatte	kg
PSC32-DSSNR/L22040-12	32	60	124	22	13.7	40	48.3	-8°	0°	SNM.. 1204..	0,210
PSC40-DSSNR/L27042-12	40	110	140	27	18.7	42	50.3	-8°	0°	SNM.. 1204..	0,350
PSC50-DSSNR/L35052-12	50	110	165	35	26.7	52	60.3	-8°	0°	SNM.. 1204..	0,700
PSC63-DSSNR/L45056-12	63	110	190	45	36.7	56	64.3	-8°	0°	SNM.. 1204..	1,120
PSC40-DSSNR/L27045-15	40	125	145	27	16.8	45	55.2	-8°	0°	SNM.. 1506..	0,400
PSC50-DSSNR/L35050-15	50	125	165	35	24.8	50	60.2	-8°	0°	SNM.. 1506..	0,680
PSC63-DSSNR/L45054-15	63	125	190	45	34.8	54	64.2	-8°	0°	SNM.. 1506..	1,140
PSC50-DSSNR/L35048-19	50	125	165	35	22.5	48	60.5	-8°	0°	SNM.. 1906..	0,700
PSC63-DSSNR/L45052-19	63	125	190	45	32.5	52	64.5	-8°	0°	SNM.. 1906..	1,130

Reference Bezeichnung							Nm
PSC32-DSSNR/L22040-12	1766	ISSN-442	2712	1696	4295	5004	3.5
PSC40-DSSNR/L27042-12	1766	ISSN-442	2712	1696	4295	5004	3.5
PSC50-DSSNR/L35052-12	1766	ISSN-442	2712	1696	4295	5004	3.5
PSC63-DSSNR/L45056-12	1766	ISSN-442	2712	1696	4295	5004	3.5
PSC40-DSSNR/L27045-15	1768	ISSN-533	2716	1696	4295	5004	3.5
PSC50-DSSNR/L35050-15	1768	ISSN-533	2716	1696	4295	5004	3.5
PSC63-DSSNR/L45054-15	1768	ISSN-533	2716	1696	4295	5004	3.5
PSC50-DSSNR/L35048-19	1770	ISSN-633	2719	1696	4295	5004	3.5
PSC63-DSSNR/L45052-19	1770	ISSN-633	2719	1696	4295	5004	3.5

SNM.. Square negative inserts. Vierkantige negative Wendeschneidplatten. A41-42

Reference / Bez.	l	s	d
SNM.. 1204..	12,70	4,76	12,70
SNM.. 1506..	15,88	6,35	15,88
SNM.. 1906..	19,05	6,35	19,05

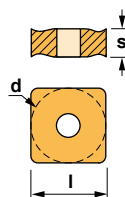

SNMG-FMC	SNMG-KC	SNMG-MHC
SNMG-RC	SNMG-TC	SNMM





Characteristics:
Toolholder for face turning applications equipped with triangular negative inserts. PSC with internal coolant.

- 1) γ = Rake angle (valid with a flat insert).
- 2) λ_s = Angle of inclination.

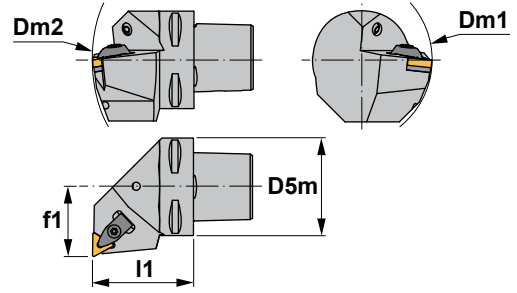

Eigenschaften:
Klemmhalter zum Plandrehen mit einer dreikantigen negativen Wendeschneidplatte. PSC mit Innenkühlung.

- 1) γ = Spanwinkel (Gültig nur mit flachen Wendeschneidplatte).
- 2) λ_s = Neigungswinkel.

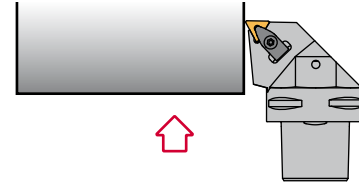

DTFN 90°

Reference Bezeichnung	D5m	Dm1 min.	Dm2 min.	f1	l1	γ^1	λ_s^2	Insert size Wendeschneidplatte	kg
PSC40-DTFNR/L27050-16	40	110	140	27	50	-6°	-6°	TNM.. 1604..	0,420
PSC50-DTFNR/L35060-16	50	110	165	35	60	-6°	-6°	TNM.. 1604..	0,800
PSC63-DTFNR/L45065-16	63	110	190	45	65	-6°	-6°	TNM.. 1604..	1,100
PSC40-DTFNR/L27050-22	40	110	140	27	50	-6°	-6°	TNM.. 2204..	0,420
PSC50-DTFNR/L35060-22	50	110	165	35	60	-6°	-6°	TNM.. 2204..	0,800
PSC63-DTFNR/L45065-22	63	110	190	45	65	-6°	-6°	TNM.. 2204..	1,100

Reference Bezeichnung							Nm
PSC40-DTFNR/L27050-16	1764	ITSN-342	2708	1695	4294	5004	3.5
PSC50-DTFNR/L35060-16	1764	ITSN-342	2708	1695	4294	5004	3.5
PSC63-DTFNR/L45065-16	1764	ITSN-342	2708	1695	4294	5004	3.5
PSC40-DTFNR/L27050-22	1766	ITSN-433	2712	1696	4295	5004	3.5
PSC50-DTFNR/L35060-22	1766	ITSN-433	2712	1696	4295	5004	3.5
PSC63-DTFNR/L45065-22	1766	ITSN-433	2712	1696	4295	5004	3.5

TNM..

Triangular negative inserts. Dreikantige negative WSP. A45-46

Reference / Bez.	l	s	d
TNM.. 1604..	16,50	4,76	9,52
TNM.. 2204..	22,00	4,76	12,70

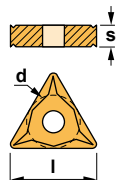



Characteristics:

Toolholder for external turning applications equipped with triangular negative inserts. PSC with internal coolant.

- 1) γ = Rake angle (valid with a flat insert).
- 2) λ_s = Angle of inclination.

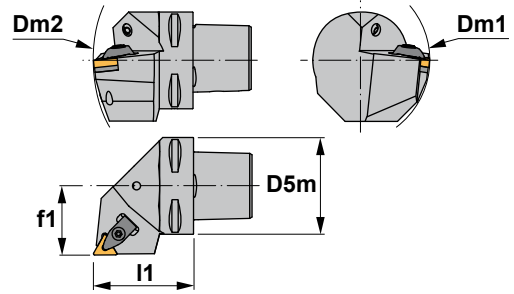

Eigenschaften:

Klemmhalter zum Außendrehen mit einer dreikantigen negativen Wendeschneidplatte. PSC mit Innenkühlung.

- 1) γ = Spanwinkel (Gültig nur mit flachen Wendeschneidplatte).
- 2) λ_s = Neigungswinkel.

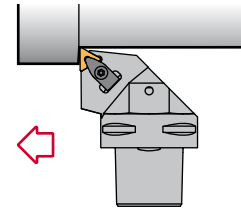

DTGN 90°

Reference Bezeichnung	D5m	Dm1 min.	Dm2 min.	f1	l1	γ^1	λ_s^2	Insert size Wendeschneidplatte	
PSC40-DTGNR/L27050-16	40	110	140	27	50	-6°	-6°	TNM.. 1604..	0,420
PSC50-DTGNR/L35060-16	50	110	165	35	60	-6°	-6°	TNM.. 1604..	0,800
PSC63-DTGNR/L45065-16	63	110	190	45	65	-6°	-6°	TNM.. 1604..	1,100
PSC40-DTGNR/L27050-22	40	110	140	27	50	-6°	-6°	TNM.. 2204..	0,420
PSC50-DTGNR/L35060-22	50	110	165	35	60	-6°	-6°	TNM.. 2204..	0,800
PSC63-DTGNR/L45065-22	63	110	190	45	65	-6°	-6°	TNM.. 2204..	1,100

Reference Bezeichnung							Nm
PSC40-DTGNR/L27050-16	1764	ITSN-342	2708	1695	4294	5004	3.5
PSC50-DTGNR/L35060-16	1764	ITSN-342	2708	1695	4294	5004	3.5
PSC63-DTGNR/L45065-16	1764	ITSN-342	2708	1695	4294	5004	3.5
PSC40-DTGNR/L27050-22	1766	ITSN-433	2712	1696	4295	5004	3.5
PSC50-DTGNR/L35060-22	1766	ITSN-433	2712	1696	4295	5004	3.5
PSC63-DTGNR/L45065-22	1766	ITSN-433	2712	1696	4295	5004	3.5

TNM.. <small>Triangular negative inserts. Dreikantige negative WSP. A45-46</small>										
Reference / Bez.	l	s	d			TNMA	TNMG-CC	TNMG-FC	TNMG-FMC	TNMG-KC
TNM.. 1604..	16,50	4,76	9,52							
TNM.. 2204..	22,00	4,76	12,70							



**Characteristics:**

Toolholder for very specific operations equipped with rhombic negative inserts (angle 35°).

PSC with internal coolant.

- 1) γ = Rake angle (valid with a flat insert).
- 2) λ_s = Angle of inclination.

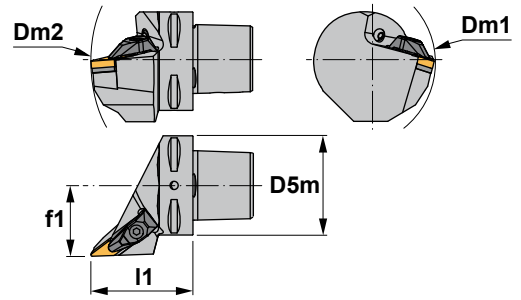
**Eigenschaften:**

Klemmhalter für sehr spezifische Anwendungen mit einer rhombischen negativen Wendschneidplatte (Winkel 35°).

PSC mit Innenkühlung.

- 1) γ = Spanwinkel (Gültig nur mit flachen Wendschneidplatte).
- 2) λ_s = Neigungswinkel.

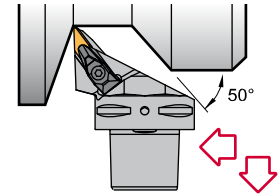

DVJN 93°

Reference Bezeichnung	D5m	Dm1 min.	Dm2 min.	f1	l1	$\gamma^{1)}$	$\lambda_s^{2)}$	Insert size Wendschneidplatte	
PSC40-DVJNR/L27062-16	40	60	152	27	62	-4°	-13°	VN.. 1604..	0,450
PSC50-DVJNR/L35065-16	50	65	170	35	65	-4°	-13°	VN.. 1604..	0,790
PSC63-DVJNR/L45065-16	63	81	190	45	65	-4°	-13°	VN.. 1604..	1,100
PSC80-DVJNR/L55080-16	80	100	250	55	80	-4°	-13°	VN.. 1604..	2,740

Reference Bezeichnung							Nm
PSC40-DVJNR/L27062-16	1764	IVSN-322	2708	1695	4294	5004	3.5
PSC50-DVJNR/L35065-16	1764	IVSN-322	2708	1695	4294	5004	3.5
PSC63-DVJNR/L45065-16	1764	IVSN-322	2708	1695	4294	5004	3.5
PSC80-DVJNR/L55080-16	1764	IVSN-322	2708	1695	4294	5004	3.5

VN..

35° rhombic negative inserts. A49
35° rhombische negative Wendschneidplatten.

Reference / Bez.	l	s	d
VN.. 1604..	16,50	4,76	9,52

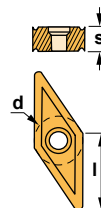
**VNGP****VNMG****VNMG-TC**



Characteristics:
Profiling toolholder equipped with rhombic negative double-sided insert (angle 35°). PSC with internal coolant.

- 1) γ = Rake angle (valid with a flat insert).
- 2) λ_s = Angle of inclination.

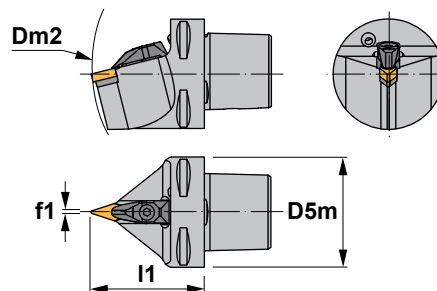

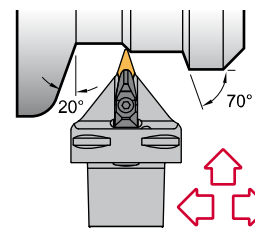

Eigenschaften:
Klemmhalter zum Drehen und Profildrehen mit einer doppelseitigen rhombischen negativen Wendeschneidplatte (Winkel 35°). PSC mit Innenkühlung.

- 1) γ = Spanwinkel (Gültig nur mit flachen Wendeschneidplatte).
- 2) λ_s = Neigungswinkel.



DVVN 72° 30'

Reference Bezeichnung	D5m	Dm2 min.	f1	l1	γ^1	λ_s^2	Insert size Wendeschneidplatte	kg
PSC40-DVVNN00062-16	40	152	0.6	62	-4°	-13°	VN.. 1604..	0,430
PSC50-DVVNN00065-16	50	170	0.6	65	-4°	-13°	VN.. 1604..	0,800
PSC63-DVVNN00065-16	63	190	0.6	65	-4°	-13°	VN.. 1604..	1,070
PSC80-DVVNN00080-16	80	250	0.6	80	-4°	-13°	VN.. 1604..	2,320

Reference Bezeichnung							Nm
PSC40-DVVNN00062-16	1764	IVSN-322	2708	1695	4294	5004	3.5
PSC50-DVVNN00065-16	1764	IVSN-322	2708	1695	4294	5004	3.5
PSC63-DVVNN00065-16	1764	IVSN-322	2708	1695	4294	5004	3.5
PSC80-DVVNN00080-16	1764	IVSN-322	2708	1695	4294	5004	3.5

VN.. 35° rhombic negative inserts.  A49
35° rhombische negative Wendeschneidplatten.

Reference / Bez.	l	s	d
VN.. 1604..	16,50	4,76	9,52

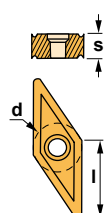

VNGP	VNMG
	
VNMG-TC	
	



**Characteristics:**

Multipurpose toolholder equipped with trigon negative double-sided insert (angle 80°).

PSC with internal coolant.

- 1) γ = Rake angle (valid with a flat insert).
- 2) λ_s = Angle of inclination.

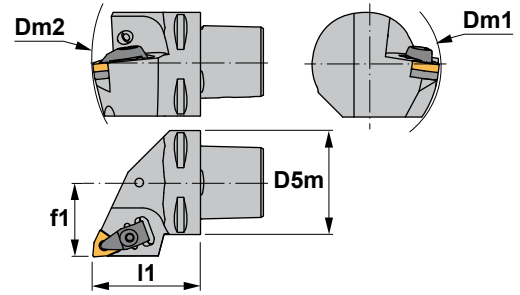
**Eigenschaften:**

Multifunktions-Klemmhalter mit einer doppelseitigen negativen Trigon-Wendeschneidplatte (Winkel 80°).

PSC mit Innenkühlung.

- 1) γ = Spanwinkel (Gültig nur mit flachen Wendeschneidplatte).
- 2) λ_s = Neigungswinkel.

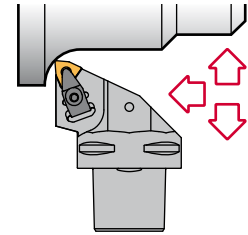

DWLN 95°

Reference Bezeichnung	D5m	Dm1 min.	Dm2 min.	f1	I1	γ^1	λ_s^2	Insert size Wendeschneidplatte	Kg
PSC32-DWLN/L22040-06	32	60	116	22	40	-6°	-6°	WNMG 0604..	0,210
PSC40-DWLN/L27050-06	40	60	140	27	50	-6°	-6°	WNMG 0604..	0,420
PSC50-DWLN/L35060-06	50	65	165	35	60	-6°	-6°	WNMG 0604..	0,800
PSC63-DWLN/L45065-06	63	81	190	45	65	-6°	-6°	WNMG 0604..	1,100
PSC40-DWLN/L27050-08	40	110	140	27	50	-6°	-6°	WNMG 0804..	0,420
PSC50-DWLN/L35060-08	50	110	165	35	60	-6°	-6°	WNMG 0804..	0,800
PSC63-DWLN/L45065-08	63	110	190	45	65	-6°	-6°	WNMG 0804..	1,100
PSC80-DWLN/L55080-08	80	110	250	55	80	-6°	-6°	WNMG 0804..	2,740

Reference Bezeichnung							Nm
PSC32-DWLN/L22040-06	1764	IWSN-322	2708	1695	4294	5004	3.5
PSC40-DWLN/L27050-06	1764	IWSN-322	2708	1695	4294	5004	3.5
PSC50-DWLN/L35060-06	1764	IWSN-322	2708	1695	4294	5004	3.5
PSC63-DWLN/L45065-06	1764	IWSN-322	2708	1695	4294	5004	3.5
PSC40-DWLN/L27050-08	1766	IWSN-433	2712	1696	4295	5004	3.5
PSC50-DWLN/L35060-08	1766	IWSN-433	2712	1696	4295	5004	3.5
PSC63-DWLN/L45065-08	1766	IWSN-433	2712	1696	4295	5004	3.5
PSC80-DWLN/L55080-08	1766	IWSN-433	2712	1696	4295	5004	3.5

WNMG

80° trigon negative inserts. A50-51
80° trigon negative Wendeschneidplatten.

Reference / Bez.	l	s	d
WNMG 0604..	6,45	4,76	9,52
WNMG 0804..	8,14	4,76	12,70

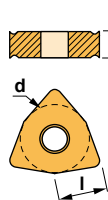



Characteristics:
Toolholder for face turning applications equipped with rhombic negative inserts (angle 80°).
PSC with internal coolant.

- 1) γ = Rake angle (valid with a flat insert).
- 2) λ_s = Angle of inclination.

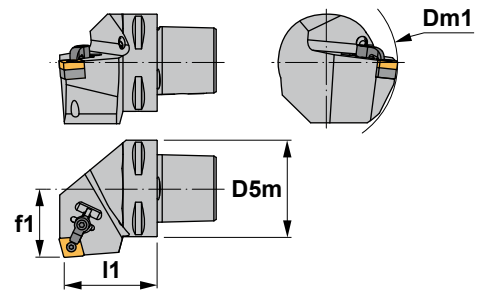

Eigenschaften:
Klemmhalter zum Plandrehen mit einer doppelseitigen rhombischen negativen Wendeschneidplatte (80° Winkel).
PSC mit Innenkühlung.

- 1) γ = Spanwinkel (Gültig nur mit flachen Wendeschneidplatte).
- 2) λ_s = Neigungswinkel.

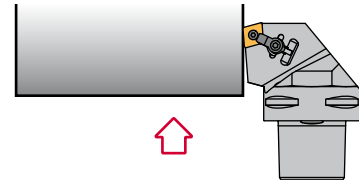

MCKN 75°

Reference Bezeichnung	D5m	Dm1 min.	f1	l1	γ^1	λ_s^2	Insert size Wendeschneidplatte	Kg
PSC40-MCKNR/L27050-12	40	110	27	50	-6°	-6°	CN.. 1204..	0,420
PSC50-MCKNR/L35060-12	50	110	35	60	-6°	-6°	CN.. 1204..	0,800
PSC63-MCKNR/L45065-12	63	110	45	65	-6°	-6°	CN.. 1204..	1,100
PSC40-MCKNR/L27050-16	40	125	27	50	-6°	-6°	CN.. 1606..	0,420
PSC50-MCKNR/L35060-16	50	125	35	60	-6°	-6°	CN.. 1606..	0,800
PSC63-MCKNR/L45065-16	63	125	45	65	-6°	-6°	CN.. 1606..	1,100
PSC63-MCKNR/L45065-19	63	125	45	65	-6°	-6°	CN.. 1906..	1,100
PSC80-MCKNR/L55080-19	80	125	55	80	-6°	-6°	CN.. 1906..	2,740

Reference Bezeichnung						Nm
PSC40-MCKNR/L27050-12	2613	1086	5003	ICSN-442	1657 5025	3.0
PSC50-MCKNR/L35060-12	2613	1086	5003	ICSN-442	1657 5025	3.0
PSC63-MCKNR/L45065-12	2613	1086	5003	ICSN-442	1657 5025	3.0
PSC40-MCKNR/L27050-16	2614	1086	5003	ICSN-533	1673 5003	3.0
PSC50-MCKNR/L35060-16	2614	1086	5003	ICSN-533	1673 5003	3.0
PSC63-MCKNR/L45065-16	2614	1086	5003	ICSN-533	1673 5003	3.0
PSC63-MCKNR/L45065-19	2614	1086	5003	ICSN-633	1674 5004	3.0
PSC80-MCKNR/L55080-19	2614	1086	5003	ICSN-633	1674 5004	3.0

CN..

80° rhombic negative inserts.
80° rhombische negative WSP. A32-34

Reference / Bez.	l	s	d
CN.. 1204..	12,90	4,76	12,70
CN.. 1606..	16,10	6,35	15,88
CN.. 1906..	19,30	6,35	19,05

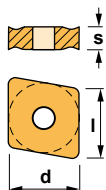



Characteristics:
Multipurpose toolholder equipped with rhombic negative double-sided insert (angle 80°). PSC with internal coolant.

- 1) γ = Rake angle (valid with a flat insert).
- 2) λ_s = Angle of inclination.

Eigenschaften:
Multifunktions-Klemmhalter mit einer doppelseitigen rhombischen Wendeschneidplatte (Winkel 80°). PSC mit Innenkühlung.

- 1) γ = Spanwinkel (Gültig nur mit flachen Wendeschneidplatte).
- 2) λ_s = Neigungswinkel.

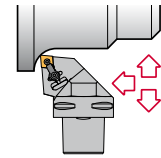
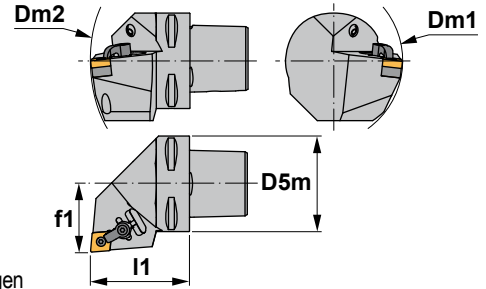

MCLN 95°

Reference Bezeichnung	D5m	Dm1 min.	Dm2 min.	f1	l1	$\gamma^1)$	$\lambda_s^2)$	Insert size Wendeschneidplatte	Kg
PSC32-MCLNR/L22040-09	32	60	116	22	40	-6°	-6°	CN.. 0903..	0,210
PSC40-MCLNR/L27050-09	40	60	140	27	50	-6°	-6°	CN.. 0903..	0,420
PSC32-MCLNR/L22045-12	32	60	121	22	45	-6°	-6°	CN.. 1204..	0,240
PSC40-MCLNR/L27050-12	40	110	140	27	50	-6°	-6°	CN.. 1204..	0,420
PSC50-MCLNR/L35060-12	50	110	165	35	60	-6°	-6°	CN.. 1204..	0,800
PSC63-MCLNR/L45065-12	63	110	190	45	65	-6°	-6°	CN.. 1204..	1,100
PSC80-MCLNR/L55080-12	80	110	250	55	80	-6°	-6°	CN.. 1204..	2,740
PSC40-MCLNR/L27055-16	40	125	145	27	55	-6°	-6°	CN.. 1606..	0,430
PSC50-MCLNR/L35060-16	50	125	165	35	60	-6°	-6°	CN.. 1606..	0,800
PSC63-MCLNR/L45065-16	63	125	190	45	65	-6°	-6°	CN.. 1606..	1,100
PSC80-MCLNR/L55080-16	80	125	250	55	80	-6°	-6°	CN.. 1606..	2,740
PSC50-MCLNR/L35060-19	50	125	165	35	60	-6°	-6°	CN.. 1906..	0,800
PSC63-MCLNR/L45065-19	63	125	190	45	65	-6°	-6°	CN.. 1906..	1,100
PSC80-MCLNR/L55080-19	80	125	250	55	80	-6°	-6°	CN.. 1906..	2,740

Reference Bezeichnung						Nm
PSC32-MCLNR/L22040-09	2604	1085	5025	ICSN-332	1665 5002	2.0
PSC40-MCLNR/L27050-09	2604	1085	5025	ICSN-332	1665 5002	2.0
PSC32-MCLNR/L22045-12	2613	1086	5003	ICSN-442	1657 5025	3.0
PSC40-MCLNR/L27050-12	2613	1086	5003	ICSN-442	1657 5025	3.0
PSC50-MCLNR/L35060-12	2613	1086	5003	ICSN-442	1657 5025	3.0
PSC63-MCLNR/L45065-12	2613	1086	5003	ICSN-442	1657 5025	3.0
PSC80-MCLNR/L55080-12	2613	1086	5003	ICSN-442	1657 5025	3.0
PSC40-MCLNR/L27055-16	2614	1086	5003	ICSN-533	1673 5003	3.0
PSC50-MCLNR/L35060-16	2614	1086	5003	ICSN-533	1673 5003	3.0
PSC63-MCLNR/L45065-16	2614	1086	5003	ICSN-533	1673 5003	3.0
PSC80-MCLNR/L55080-16	2614	1086	5003	ICSN-533	1673 5003	3.0
PSC50-MCLNR/L35060-19	2614	1086	5003	ICSN-633	1674 5004	3.0
PSC63-MCLNR/L45065-19	2614	1086	5003	ICSN-633	1674 5004	3.0
PSC80-MCLNR/L55080-19	2614	1086	5003	ICSN-633	1674 5004	3.0

CN..

80° rhombic negative inserts.
80° rhombische negative WSP. A32-34

Reference / Bez.	l	s	d
CN.. 0903..	9,65	3,18	9,52
CN.. 1204..	12,90	4,76	12,70
CN.. 1606..	16,10	6,35	15,88
CN.. 1906..	19,30	6,35	19,05

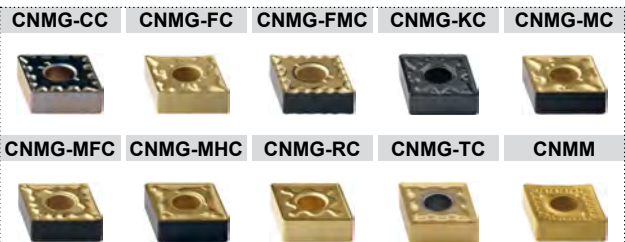
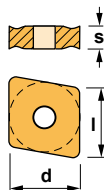



Characteristics:

Toolholder for external turning applications equipped with rhombic negative inserts (angle 80°).
PSC with internal coolant.

- 1) γ = Rake angle (valid with a flat insert).
- 2) λ_s = Angle of inclination.

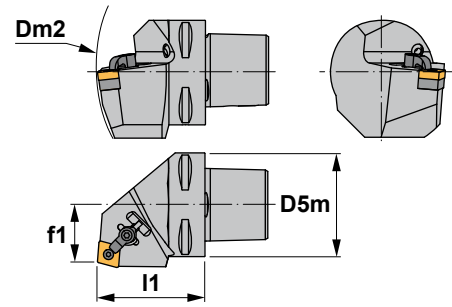

Eigenschaften:

Klemmhalter zum Außendrehen mit einer rhombischen negativen Wendeschneidplatte (80° Winkel).
PSC mit Innenkühlung.

- 1) γ = Spanwinkel (Gültig nur mit flachen Wendeschneidplatte).
- 2) λ_s = Neigungswinkel.

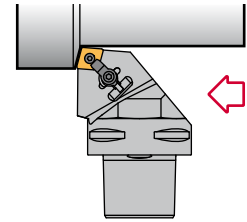

MCRN 75°

Reference Bezeichnung	D5m	Dm2 min.	f1	l1	γ^1	λ_s^2	Insert size Wendeschneidplatte	⚖️ Kg
PSC40-MCRNR/L22050-12	40	140	22	50	-6°	-6°	CN.. 1204..	0,420
PSC50-MCRNR/L27060-12	50	165	27	60	-6°	-6°	CN.. 1204..	0,800
PSC63-MCRNR/L35065-12	63	190	35	65	-6°	-6°	CN.. 1204..	1,400
PSC50-MCRNR/L27060-16	50	165	27	60	-6°	-6°	CN.. 1606..	0,800
PSC63-MCRNR/L35065-16	63	190	35	65	-6°	-6°	CN.. 1606..	1,400
PSC80-MCRNR/L55080-16	80	250	55	80	-6°	-6°	CN.. 1606..	2,740
PSC50-MCRNR/L27060-19	50	165	27	60	-6°	-6°	CN.. 1906..	0,800
PSC63-MCRNR/L35065-19	63	190	35	65	-6°	-6°	CN.. 1906..	1,400
PSC80-MCRNR/L55080-19	80	250	55	80	-6°	-6°	CN.. 1906..	2,740

Reference Bezeichnung							Nm
PSC40-MCRNR/L22050-12	2613	1086	5003	ICSN-442	1657	5025	3.0
PSC50-MCRNR/L27060-12	2613	1086	5003	ICSN-442	1657	5025	3.0
PSC63-MCRNR/L35065-12	2613	1086	5003	ICSN-442	1657	5025	3.0
PSC50-MCRNR/L27060-16	2614	1086	5003	ICSN-533	1673	5003	3.0
PSC63-MCRNR/L35065-16	2614	1086	5003	ICSN-533	1673	5003	3.0
PSC80-MCRNR/L55080-16	2614	1086	5003	ICSN-533	1673	5003	3.0
PSC50-MCRNR/L27060-19	2614	1086	5003	ICSN-633	1674	5004	3.0
PSC63-MCRNR/L35065-19	2614	1086	5003	ICSN-633	1674	5004	3.0
PSC80-MCRNR/L55080-19	2614	1086	5003	ICSN-633	1674	5004	3.0

CN..

80° rhombic negative inserts.
80° rhombische negative WSP. A32-34

Reference / Bez.	l	s	d
CN.. 1204..	12,90	4,76	12,70
CN.. 1606..	16,10	6,35	15,88
CN.. 1906..	19,30	6,35	19,05

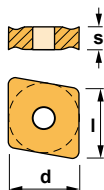



Characteristics:
Turning and profiling toolholder equipped with rhombic negative double-sided insert (angle 55°).
PSC with internal coolant.

- 1) γ = Rake angle (valid with a flat insert).
- 2) λ_s = Angle of inclination.

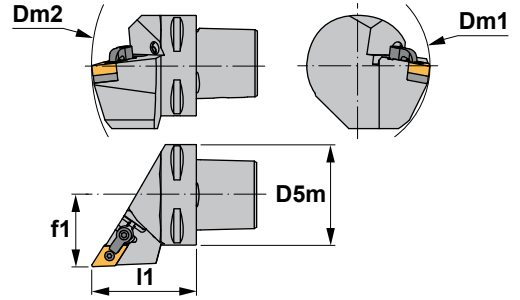

Eigenschaften:
Klemmhalter zum Drehen und Profildrehen mit einer doppelseitigen rhombischen negativen Wendeschneidplatte (Winkel 55°).
PSC mit Innenkühlung.

- 1) γ = Spanwinkel (Gültig nur mit flachen Wendeschneidplatte).
- 2) λ_s = Neigungswinkel.

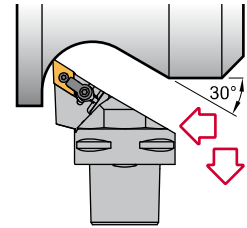

MDJN 93°

Reference Bezeichnung	D5m	Dm1 min.	Dm2 min.	f1	l1	$\gamma^1)$	$\lambda_s^2)$	Insert size Wendeschneidplatte	Kg
PSC32-MDJNR/L22045-11	32	60	121	22	45	-6°	-7°	DN.. 1104..	0,240
PSC40-MDJNR/L27050-11	40	60	140	27	50	-6°	-7°	DN.. 1104..	0,420
PSC50-MDJNR/L35060-11	50	65	165	35	60	-6°	-7°	DN.. 1104..	0,800
PSC63-MDJNR/L45065-11	63	81	190	45	65	-6°	-7°	DN.. 1104..	1,100
PSC40-MDJNR/L27055-15	40	110	145	27	55	-6°	-7°	DN.. 1506..	0,430
PSC50-MDJNR/L35060-15	50	110	165	35	60	-6°	-7°	DN.. 1506..	0,800
PSC63-MDJNR/L45065-15	63	110	190	45	65	-6°	-7°	DN.. 1506..	1,100
PSC80-MDJNR/L55080-15	80	110	250	55	80	-6°	-7°	DN.. 1506..	2,740

Reference Bezeichnung							Nm
PSC32-MDJNR/L22045-11	2604	1085	5025	IDSN-322	1665	5002	2.0
PSC40-MDJNR/L27050-11	2604	1085	5025	IDSN-322	1665	5002	2.0
PSC50-MDJNR/L35060-11	2604	1085	5025	IDSN-322	1665	5002	2.0
PSC63-MDJNR/L45065-11	2604	1085	5025	IDSN-322	1665	5002	2.0
PSC40-MDJNR/L27055-15	2613	1086	5003	IDSN-432	1657	5025	3.0
PSC50-MDJNR/L35060-15	2613	1086	5003	IDSN-432	1657	5025	3.0
PSC63-MDJNR/L45065-15	2613	1086	5003	IDSN-432	1657	5025	3.0
PSC80-MDJNR/L55080-15	2613	1086	5003	IDSN-432	1657	5025	3.0

DN.. 55° rhombic negative inserts. A36-37
55° rhombische negative Wendeschneidplatten.

Reference / Bez.	l	s	d
DN.. 1104..	11,60	4,76	9,52
DN.. 1506..	15,50	6,35	12,70

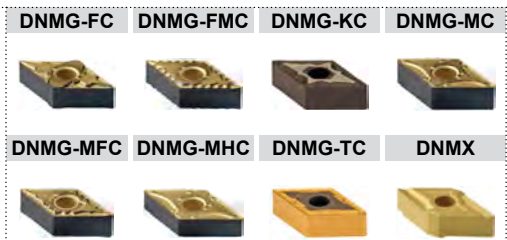
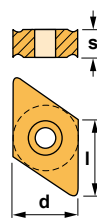



Characteristics:

Turning and profiling toolholder equipped with rhombic negative double-sided insert (angle 55°).
PSC with internal coolant.

- 1) γ = Rake angle (valid with a flat insert).
- 2) λ_s = Angle of inclination.

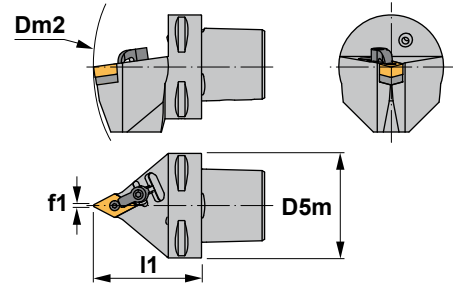

Eigenschaften:

Klemmhalter zum Drehen und Profildrehen mit einer doppelseitigen rhombischen negativen Wendeschneidplatte (Winkel 55°).
PSC mit Innenkühlung.

- 1) γ = Spanwinkel (Gültig nur mit flachen Wendeschneidplatte).
- 2) λ_s = Neigungswinkel.

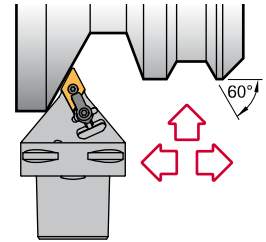

MDNN 63°

Reference Bezeichnung	D5m	Dm2 min.	f1	l1	γ^1	λ_s^2	Insert size Wendeschneidplatte	KG
PSC40-MDNNN00050-11	40	140	0.5	50	-5°	-9°	DN.. 1104..	0,350
PSC50-MDNNN00060-11	50	165	0.5	60	-5°	-9°	DN.. 1104..	0,750
PSC40-MDNNN00055-15	40	145	0.5	55	-5°	-9°	DN.. 1506..	0,370
PSC50-MDNNN00060-15	50	165	0.5	60	-5°	-9°	DN.. 1506..	0,750
PSC63-MDNNN00065-15	63	190	0.5	65	-5°	-9°	DN.. 1506..	1,070
PSC80-MDNNN00080-15	80	250	0.5	80	-5°	-9°	DN.. 1506..	2,320

Reference Bezeichnung						Nm
PSC40-MDNNN00050-11	2604	1085	5025	IDSN-322	1665 5002	2.0
PSC50-MDNNN00060-11	2604	1085	5025	IDSN-322	1665 5002	2.0
PSC40-MDNNN00055-15	2613	1086	5003	IDSN-432	1657 5025	3.0
PSC50-MDNNN00060-15	2613	1086	5003	IDSN-432	1657 5025	3.0
PSC63-MDNNN00065-15	2613	1086	5003	IDSN-432	1657 5025	3.0
PSC80-MDNNN00080-15	2613	1086	5003	IDSN-432	1657 5025	3.0

DN.. 55° rhombic negative inserts. A36-37
55° rhombische negative Wendeschneidplatten.

Reference / Bez.	l	s	d
DN.. 1104..	11,60	4,76	9,52
DN.. 1506..	15,50	6,35	12,70

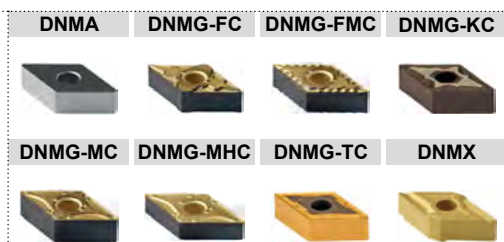
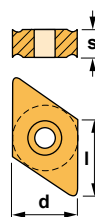



Characteristics:
Turning and profiling toolholder equipped with rhombic negative double-sided insert (angle 55°).
PSC with internal coolant.

- 1) γ = Rake angle (valid with a flat insert).
- 2) $\lambda.s$ = Angle of inclination.

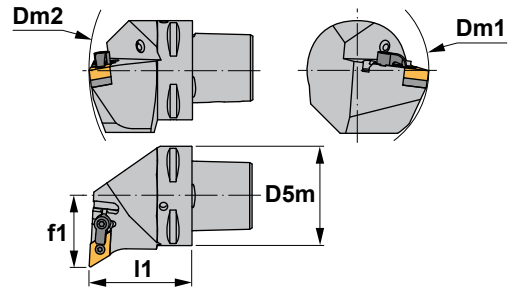

Eigenschaften:
Klemmhalter zum Drehen und Profildrehen mit einer doppelseitigen rhombischen negativen Wendeschneidplatte (Winkel 55°).
PSC mit Innenkühlung.

- 1) γ = Spanwinkel (Gültig nur mit flachen Wendeschneidplatte).
- 2) $\lambda.s$ = Neigungswinkel.

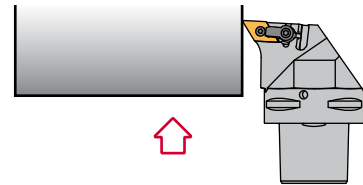

MDUN 93°

Reference Bezeichnung	D5m	Dm1 min.	Dm2 min.	f1	l1	γ^1	$\lambda.s^2$	Insert size Wendeschneidplatte	kg
PSC40-MDUNR/L27050-15	40	110	140	27	50	-6°	-7°	DN.. 1506..	0,420
PSC50-MDUNR/L35060-15	50	110	165	35	60	-6°	-7°	DN.. 1506..	0,800
PSC63-MDUNR/L45065-15	63	110	190	45	65	-6°	-7°	DN.. 1506..	1,100
PSC80-MDUNR/L55080-15	80	110	250	55	80	-6°	-7°	DN.. 1506..	2,740

Reference Bezeichnung							Nm
PSC40-MDUNR/L27050-15	2613	1086	5003	IDSN-432	1657	5025	3.0
PSC50-MDUNR/L35060-15	2613	1086	5003	IDSN-432	1657	5025	3.0
PSC63-MDUNR/L45065-15	2613	1086	5003	IDSN-432	1657	5025	3.0
PSC80-MDUNR/L55080-15	2613	1086	5003	IDSN-432	1657	5025	3.0

DN.. 55° rhombic negative inserts. A36-37
55° rhombische negative Wendeschneidplatten.

Reference / Bez.	l	s	d
DN.. 1506..	15,50	6,35	12,70

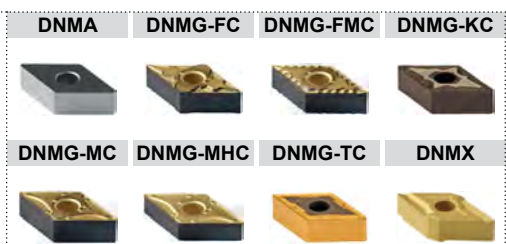
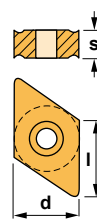



Characteristics:

Toolholder for external turning and chamfering applications equipped with square negative inserts.

PSC with internal coolant.

- 1) γ = Rake angle (valid with a flat insert).
- 2) λ_s = Angle of inclination.

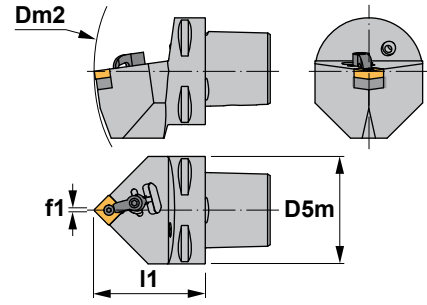

Eigenschaften:

Klemmhalter zum Außendrehen und Abschrägen mit einer vierkantigen negativen Wendeschneidplatte.

PSC mit Innenkühlung.

- 1) γ = Spanwinkel (Gültig nur mit flachen Wendeschneidplatte).
- 2) λ_s = Neigungswinkel.

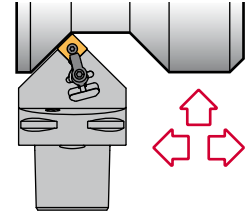

MSDN 45°

Reference Bezeichnung	D5m	Dm2 min.	f1	l1	γ^1	λ_s^2	Insert size Wendeschneidplatte	Kg
PSC32-MSDNN00048-12	32	124	0.3	48	-6°	-6°	SNM.. 1204..	0,240
PSC40-MSDNN00050-12	40	140	0.3	50	-6°	-6°	SNM.. 1204..	0,350
PSC50-MSDNN00060-12	50	165	0.3	60	-6°	-6°	SNM.. 1204..	0,750
PSC63-MSDNN00065-12	63	190	0.3	65	-6°	-6°	SNM.. 1204..	1,070
PSC50-MSDNN00060-15	50	165	0.5	60	-6°	-6°	SNM.. 1506..	0,750
PSC63-MSDNN00065-15	63	190	0.5	65	-6°	-6°	SNM.. 1506..	1,070
PSC50-MSDNN00065-19	50	170	0.5	65	-6°	-6°	SNM.. 1906..	0,800
PSC63-MSDNN00070-19	63	195	0.5	70	-6°	-6°	SNM.. 1906..	1,260

Reference Bezeichnung							Nm
PSC32-MSDNN00048-12	2613	1086	5003	ISSN-442	1657	5025	3.0
PSC40-MSDNN00050-12	2613	1086	5003	ISSN-442	1657	5025	3.0
PSC50-MSDNN00060-12	2613	1086	5003	ISSN-442	1657	5025	3.0
PSC63-MSDNN00065-12	2613	1086	5003	ISSN-442	1657	5025	3.0
PSC50-MSDNN00060-15	2614	1086	5003	ISSN-533	1673	5003	3.0
PSC63-MSDNN00065-15	2614	1086	5003	ISSN-533	1673	5003	3.0
PSC50-MSDNN00065-19	2614	1086	5003	ISSN-633	1674	5004	3.0
PSC63-MSDNN00070-19	2614	1086	5003	ISSN-633	1674	5004	3.0

SNM.. <small>Square negative inserts. Vierkantige negative Wendeschneidplatten. A41-42</small>			
Reference / Bez.	l	s	d
SNM.. 1204..	12,70	4,76	12,70
SNM.. 1506..	15,88	6,35	15,88
SNM.. 1906..	19,05	6,35	19,05

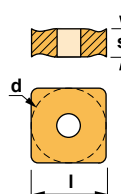

SNMG-FMC	SNMG-KC	SNMG-MHC
SNMG-RC	SNMG-TC	SNMM





Characteristics:

Toolholder for face turning applications equipped with square negative inserts. PSC with internal coolant.

- 1) γ = Rake angle (valid with a flat insert).
- 2) λ_s = Angle of inclination.

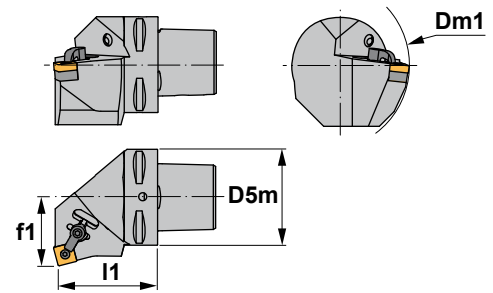

Eigenschaften:

Klemmhalter zum Plandrehen mit einer vierkantigen negativen Wendeschneidplatte. PSC mit Innenkühlung.

- 1) γ = Spanwinkel (Gültig nur mit flachen Wendeschneidplatte).
- 2) λ_s = Neigungswinkel.

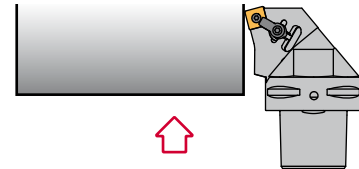

MSKN 75°

Reference Bezeichnung	D5m	Dm1 min.	f1	l1	$\gamma^{1)}$	$\lambda_s^{2)}$	Insert size Wendeschneidplatte	
PSC32-MSKNR/L22040-12	32	60	22	40	-6°	-6°	SNM.. 1204..	0,210
PSC40-MSKNR/L27050-12	40	110	27	50	-6°	-6°	SNM.. 1204..	0,420
PSC50-MSKNR/L35060-12	50	110	35	60	-6°	-6°	SNM.. 1204..	0,800
PSC63-MSKNR/L45065-12	63	110	45	65	-6°	-6°	SNM.. 1204..	1,100
PSC50-MSKNR/L35060-15	50	125	35	60	-6°	-6°	SNM..1506..	0,800
PSC63-MSKNR/L45065-15	63	125	45	65	-6°	-6°	SNM..1506..	1,100
PSC50-MSKNR/L35060-19	50	125	35	60	-6°	-6°	SNM.. 1906..	0,800
PSC63-MSKNR/L45065-19	63	125	45	65	-6°	-6°	SNM.. 1906..	1,100
PSC80-MSKNR/L55080-19	80	125	55	80	-6°	-6°	SNM.. 1906..	2,740

Reference Bezeichnung						Nm
PSC32-MSKNR/L22040-12	2613	1086	5003	ISSN-442	1657 5025	3.0
PSC40-MSKNR/L27050-12	2613	1086	5003	ISSN-442	1657 5025	3.0
PSC50-MSKNR/L35060-12	2613	1086	5003	ISSN-442	1657 5025	3.0
PSC63-MSKNR/L45065-12	2613	1086	5003	ISSN-442	1657 5025	3.0
PSC50-MSKNR/L35060-15	2614	1086	5003	ISSN-533	1673 5003	3.0
PSC63-MSKNR/L45065-15	2614	1086	5003	ISSN-533	1673 5003	3.0
PSC50-MSKNR/L35060-19	2614	1086	5003	ISSN-633	1674 5004	3.0
PSC63-MSKNR/L45065-19	2614	1086	5003	ISSN-633	1674 5004	3.0
PSC80-MSKNR/L55080-19	2614	1086	5003	ISSN-633	1674 5004	3.0

SNM..

Square negative inserts. Vierkantige negative Wendeschneidplatten. A41-42

Reference / Bez.	l	s	d
SNM.. 1204..	12,70	4,76	12,70
SNM.. 1506..	15,88	6,35	15,88
SNM.. 1906..	19,05	6,35	19,05

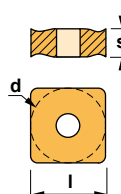



Characteristics:

Toolholder for face turning applications equipped with square negative inserts. PSC with internal coolant.

- 1) γ = Rake angle (valid with a flat insert).
- 2) λ_s = Angle of inclination.

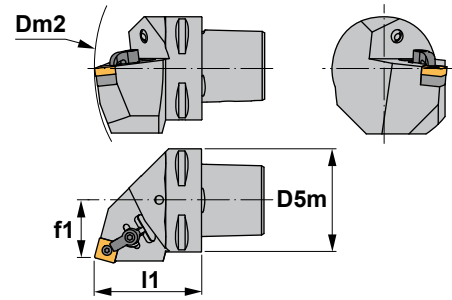

Eigenschaften:

Klemmhalter zum Plandrehen mit einer vierkantigen negativen Wendschneidplatte. PSC mit Innenkühlung.

- 1) γ = Spanwinkel (Gültig nur mit flachen Wendschneidplatte).
- 2) λ_s = Neigungswinkel.

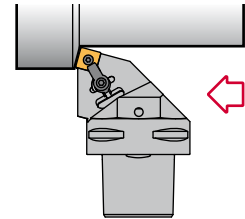

MSRN 75°

Reference Bezeichnung	D5m	Dm2 min.	f1	l1	γ^1	λ_s^2	Insert size Wendschneidplatte	
PSC32-MSRNR/L19048-12	32	124	19	48	-6°	-6°	SNM.. 1204..	0,260
PSC40-MSRNR/L22050-12	40	140	22	50	-6°	-6°	SNM.. 1204..	0,420
PSC50-MSRNR/L27060-12	50	165	27	60	-6°	-6°	SNM.. 1204..	0,800
PSC63-MSRNR/L35065-12	63	190	35	65	-6°	-6°	SNM.. 1204..	1,400
PSC50-MSRNR/L27060-15	50	165	27	60	-6°	-6°	SNM.. 1506..	0,800
PSC63-MSRNR/L35065-15	63	190	35	65	-6°	-6°	SNM.. 1506..	1,400
PSC50-MSRNR/L27060-19	50	165	27	60	-6°	-6°	SNM.. 1906..	0,800
PSC63-MSRNR/L35065-19	63	190	35	65	-6°	-6°	SNM.. 1906..	1,400
PSC80-MSRNR/L45080-19	80	250	45	80	-6°	-6°	SNM.. 1906..	2,800

Reference Bezeichnung								Nm
PSC32-MSRNR/L19048-12	2613	1086	5003	ISSN-442	1657	5025		3.0
PSC40-MSRNR/L22050-12	2613	1086	5003	ISSN-442	1657	5025		3.0
PSC50-MSRNR/L27060-12	2613	1086	5003	ISSN-442	1657	5025		3.0
PSC63-MSRNR/L35065-12	2613	1086	5003	ISSN-442	1657	5025		3.0
PSC50-MSRNR/L27060-15	2614	1086	5003	ISSN-533	1673	5003		3.0
PSC63-MSRNR/L35065-15	2614	1086	5003	ISSN-533	1673	5003		3.0
PSC50-MSRNR/L27060-19	2614	1086	5003	ISSN-633	1674	5004		3.0
PSC63-MSRNR/L35065-19	2614	1086	5003	ISSN-633	1674	5004		3.0
PSC80-MSRNR/L45080-19	2614	1086	5003	ISSN-633	1674	5004		3.0

SNM..

Square negative inserts.
Vierkantige negative Wendschneidplatten. A41-42

Reference / Bez.	l	s	d
SNM.. 1204..	12,70	4,76	12,70
SNM.. 1506..	15,88	6,35	15,88
SNM.. 1906..	19,05	6,35	19,05

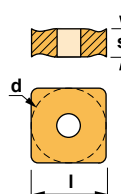

SNMG-FMC



SNMG-KC



SNMG-MHC



SNMG-RC



SNMG-TC



SNMM





Characteristics:

Toolholder for external turning and chamfering applications equipped with square negative inserts.
PSC with internal coolant.

- 1) γ = Rake angle (valid with a flat insert).
- 2) λ_s = Angle of inclination.

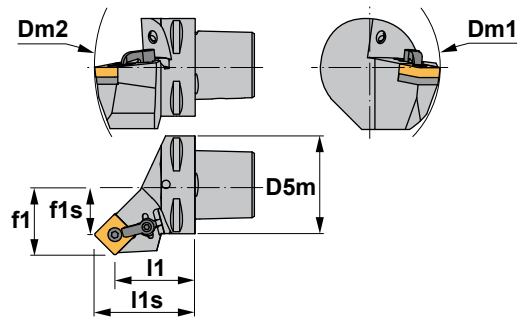

Eigenschaften:

Klemmhalter zum Außendreien und Abschrägen mit einer vierkantigen negativen Wendeschneidplatte.
PSC mit Innenkühlung.

- 1) γ = Spanwinkel (Gültig nur mit flachen Wendeschneidplatte).
- 2) λ_s = Neigungswinkel.

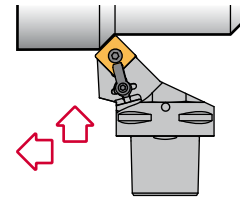

MSSN 45°

Reference Bezeichnung	D5m	Dm1 min.	Dm2 min.	f1	f1s	l1	l1s	γ^1	λ_s^2	Insert size Wendeschneidplatte	kg
PSC32-MSSNR/L22040-12	32	60	124	22	13.7	40	48.3	-8°	0°	SNM.. 1204..	0,210
PSC40-MSSNR/L27042-12	40	110	140	27	18.7	42	50.3	-8°	0°	SNM.. 1204..	0,350
PSC50-MSSNR/L35052-12	50	110	165	35	26.7	52	60.3	-8°	0°	SNM.. 1204..	0,700
PSC63-MSSNR/L45056-12	63	110	190	45	36.7	56	64.3	-8°	0°	SNM.. 1204..	1,120
PSC40-MSSNR/L27045-15	40	125	145	27	16.8	45	55.2	-8°	0°	SNM.. 1506..	0,400
PSC50-MSSNR/L35050-15	50	125	165	35	24.8	50	60.2	-8°	0°	SNM.. 1506..	0,680
PSC63-MSSNR/L45054-15	63	125	190	45	34.8	54	64.2	-8°	0°	SNM.. 1506..	1,140
PSC50-MSSNR/L35048-19	50	125	165	35	22.5	48	60.5	-8°	0°	SNM.. 1906..	0,700
PSC63-MSSNR/L45052-19	63	125	190	45	32.5	52	64.5	-8°	0°	SNM.. 1906..	1,130

Reference Bezeichnung							Nm
PSC32-MSSNR/L22040-12	2613	1086	5003	ISSN-442	1657	5025	3.0
PSC40-MSSNR/L27042-12	2613	1086	5003	ISSN-442	1657	5025	3.0
PSC50-MSSNR/L35052-12	2613	1086	5003	ISSN-442	1657	5025	3.0
PSC63-MSSNR/L45056-12	2613	1086	5003	ISSN-442	1657	5025	3.0
PSC40-MSSNR/L27045-15	2614	1086	5003	ISSN-533	1673	5003	3.0
PSC50-MSSNR/L35050-15	2614	1086	5003	ISSN-533	1673	5003	3.0
PSC63-MSSNR/L45054-15	2614	1086	5003	ISSN-533	1673	5003	3.0
PSC50-MSSNR/L35048-19	2614	1086	5003	ISSN-633	1674	5004	3.0
PSC63-MSSNR/L45052-19	2614	1086	5003	ISSN-633	1674	5004	3.0

SNM..

Square negative inserts. A41-42
Vierkantige negative Wendeschneidplatten.

Reference / Bez.	l	s	d
SNM.. 1204..	12,70	4,76	12,70
SNM.. 1506..	15,88	6,35	15,88
SNM.. 1906..	19,05	6,35	19,05

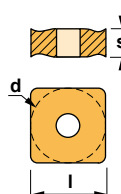

SNMG-FMC

SNMG-KC

SNMG-MHC



SNMG-RC

SNMG-TC

SNMM





Characteristics:
Toolholder for face turning applications equipped with triangular negative inserts. PSC with internal coolant.

- 1) γ = Rake angle (valid with a flat insert).
- 2) λ_s = Angle of inclination.

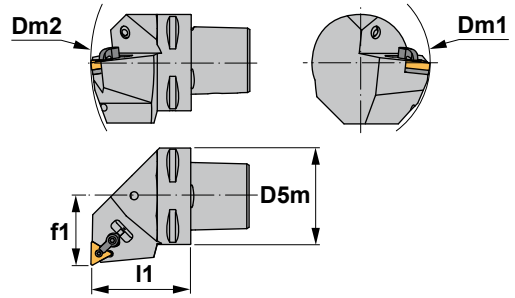

Eigenschaften:
Klemmhalter zum Plandrehen mit einer dreikantigen negativen Wendeschneidplatte. PSC mit Innenkühlung.

- 1) γ = Spanwinkel (Gültig nur mit flachen Wendeschneidplatte).
- 2) λ_s = Neigungswinkel.

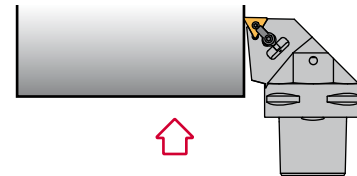

MTFN 90°

Reference Bezeichnung	D5m	Dm1 min.	Dm2 min.	f1	l1	γ^1	λ_s^2	Insert size Wendeschneidplatte	kg
PSC32-MTFNR/L22040-16	32	60	116	22	40	-6°	-6°	TNM.. 1604..	0,210
PSC40-MTFNR/L27050-16	40	110	140	27	50	-6°	-6°	TNM.. 1604..	0,420
PSC50-MTFNR/L35060-16	50	110	165	35	60	-6°	-6°	TNM.. 1604..	0,800
PSC63-MTFNR/L45065-16	63	110	190	45	65	-6°	-6°	TNM.. 1604..	1,100

Reference Bezeichnung							Nm
PSC32-MTFNR/L22040-16	2604	1085	5025	ITSN-342	1675	5002	2.0
PSC40-MTFNR/L27050-16	2604	1085	5025	ITSN-342	1675	5002	2.0
PSC50-MTFNR/L35060-16	2604	1085	5025	ITSN-342	1675	5002	2.0
PSC63-MTFNR/L45065-16	2604	1085	5025	ITSN-342	1675	5002	2.0

TNM.. Triangular negative inserts. Dreikantige negative WSP. A45-46

Reference / Bez.	l	s	d
TNM.. 1604..	16,50	4,76	9,52

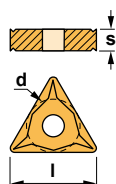



Characteristics:
Toolholder for external turning applications equipped with triangular negative inserts. PSC with internal coolant.

- 1) γ = Rake angle (valid with a flat insert).
- 2) λ_s = Angle of inclination.

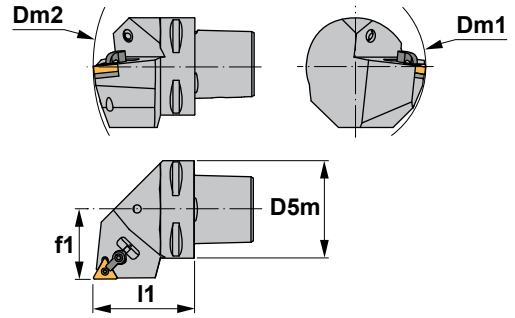

Eigenschaften:
Klemmhalter zum Außendrehen mit einer dreikantigen negativen Wendeschneidplatte. PSC mit Innenkühlung.

- 1) γ = Spanwinkel (Gültig nur mit flachen Wendeschneidplatte).
- 2) λ_s = Neigungswinkel.

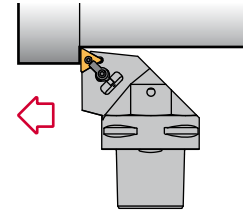

MTGN 90°

Reference Bezeichnung	D5m	Dm1 min.	Dm2 min.	f1	l1	γ^1	λ_s^2	Insert size Wendeschneidplatte	kg
PSC40-MTGNR/L27050-16	40	110	140	27	50	-6°	-6°	TNM.. 1604..	0,420
PSC50-MTGNR/L35060-16	50	110	165	35	60	-6°	-6°	TNM.. 1604..	0,800
PSC63-MTGNR/L45065-16	63	110	190	45	65	-6°	-6°	TNM.. 1604..	1,100

Reference Bezeichnung							Nm
PSC40-MTGNR/L27050-16	2604	1085	5025	ITSN-342	1675	5002	2.0
PSC50-MTGNR/L35060-16	2604	1085	5025	ITSN-342	1675	5002	2.0
PSC63-MTGNR/L45065-16	2604	1085	5025	ITSN-342	1675	5002	2.0

TNM..	Triangular negative inserts. A45-46 Dreikantige negative WSP.		
Reference / Bez.	l	s	d
TNM.. 1604..	16,50	4,76	9,52

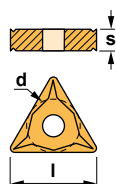



Characteristics:

Toolholder for external turning applications equipped with triangular negative inserts. PSC with internal coolant.

- 1) γ = Rake angle (valid with a flat insert).
- 2) λ_s = Angle of inclination.

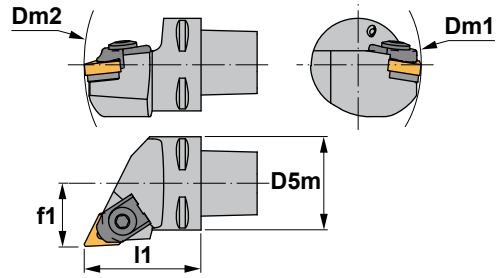

Eigenschaften:

Klemmhalter zum Außendrehen mit einer dreikantigen negativen Wendeschneidplatte. PSC mit Innenkühlung.

- 1) γ = Spanwinkel (Gültig nur mit flachen Wendeschneidplatte).
- 2) λ_s = Neigungswinkel.

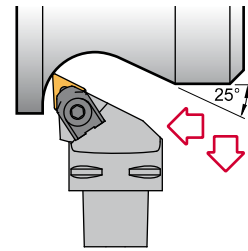

MTJN 93°

Reference Bezeichnung	D5m	Dm1 min.	Dm2 min.	f1	l1	γ^1	λ_s^2	Insert size Wendeschneidplatte	KG
PSC32-MTJNR/L22040-16	32	60	116	22	40	-6°	-6°	TNM.. 1604..	0,210
PSC40-MTJNR/L27050-16	40	110	140	27	50	-6°	-6°	TNM.. 1604..	0,420
PSC50-MTJNR/L35060-16	50	110	165	35	60	-6°	-6°	TNM.. 1604..	0,800
PSC63-MTJNR/L45065-16	63	110	190	45	65	-6°	-6°	TNM.. 1604..	1,100
PSC40-MTJNR/L27050-22	40	110	140	27	50	-6°	-6°	TNM.. 2204..	0,420
PSC50-MTJNR/L35060-22	50	110	165	35	60	-6°	-6°	TNM.. 2204..	0,800
PSC63-MTJNR/L45065-22	63	110	190	45	65	-6°	-6°	TNM.. 2204..	1,100

Reference Bezeichnung						Nm
PSC32-MTJNR/L22040-16	2014	5005	3414	1642	1393	4.0
PSC40-MTJNR/L27050-16	2014	5005	3414	1642	1393	4.0
PSC50-MTJNR/L35060-16	2014	5005	3414	1642	1393	4.0
PSC63-MTJNR/L45065-16	2014	5005	3414	1642	1393	4.0
PSC40-MTJNR/L27050-22	2024	5005	ITSN-433	1661	1394	4.0
PSC50-MTJNR/L35060-22	2024	5005	ITSN-433	1661	1394	4.0
PSC63-MTJNR/L45065-22	2024	5005	ITSN-433	1661	1394	4.0

TNM..	Triangular negative inserts. Dreikantige negative WSP. A45-46				TNMA	TNMG-CC	TNMG-FC	TNMG-FMC	TNMG-KC
	Reference / Bez.	l	s		d				
TNM.. 1604..	16,50	4,76	9,52						
TNM.. 2204..	22,00	4,76	12,70						





Characteristics:
Toolholder for very specific operations equipped with rhombic negative inserts (angle 35°).
PSC with internal coolant.

- 1) γ = Rake angle (valid with a flat insert).
- 2) λ_s = Angle of inclination.

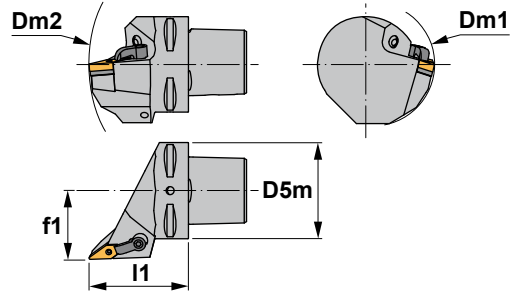

Eigenschaften:
Klemmhalter für sehr spezifische Anwendungen mit einer rhombischen negativen Wendeschneidplatte (Winkel 35°).
PSC mit Innenkühlung.

- 1) γ = Spanwinkel (Gültig nur mit flachen Wendeschneidplatte).
- 2) λ_s = Neigungswinkel.

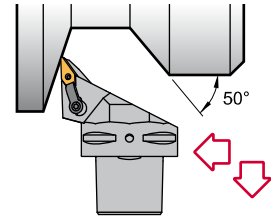

MVJN 93°

Reference Bezeichnung	D5m	Dm1 min.	Dm2 min.	f1	l1	γ^1	λ_s^2	Insert size Wendeschneidplatte	Kg
PSC40-MVJNR/L27062-16	40	60	152	27	62	-4°	-13°	VN.. 1604..	0,450
PSC50-MVJNR/L35065-16	50	65	170	35	65	-4°	-13°	VN.. 1604..	0,790
PSC63-MVJNR/L45065-16	63	81	190	45	65	-4°	-13°	VN.. 1604..	1,100
PSC80-MVJNR/L55080-16	80	100	250	55	80	-4°	-13°	VN.. 1604..	2,740

Reference Bezeichnung							Nm
PSC40-MVJNR/L27062-16	2616	1086	5003	IVSN-322	1665	5002	2.0
PSC50-MVJNR/L35065-16	2616	1086	5003	IVSN-322	1665	5002	2.0
PSC63-MVJNR/L45065-16	2616	1086	5003	IVSN-322	1665	5002	2.0
PSC80-MVJNR/L55080-16	2616	1086	5003	IVSN-322	1665	5002	2.0

VN.. 35° rhombic negative inserts. A49
35° rhombische negative Wendeschneidplatten.

Reference / Bez.	l	s	d
VN.. 1604..	16,50	4,76	9,52

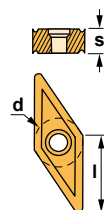

VNGP

VNMG



VNMG-TC





Characteristics:

Profiling toolholder equipped with rhombic negative double-sided insert (angle 35°). PSC with internal coolant.

- 1) γ = Rake angle (valid with a flat insert).
- 2) λ_s = Angle of inclination.

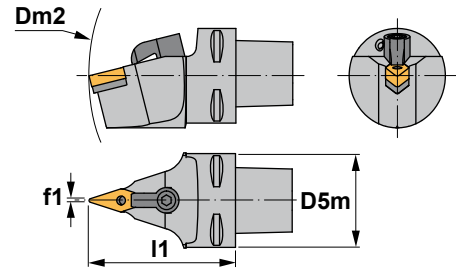

Eigenschaften:



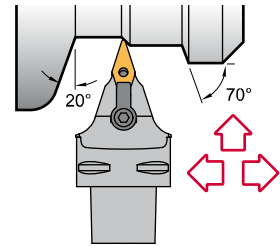

Klemmhalter zum Drehen und Profildrehen mit einer doppelseitigen rhombischen negativen Wendeschneidplatte (Winkel 35°). PSC mit Innenkühlung.

- 1) γ = Spanwinkel (Gültig nur mit flachen Wendeschneidplatte).
- 2) λ_s = Neigungswinkel.



MVVN 72° 30'

Reference Bezeichnung	D5m	Dm2 min.	f1	I1	$\gamma^1)$	$\lambda_s^2)$	Insert size Wendeschneidplatte	KG
PSC40-MVVNN00062-16	40	152	0.6	62	-4°	-13°	VN.. 1604..	0,430
PSC50-MVVNN00065-16	50	170	0.6	65	-4°	-13°	VN.. 1604..	0,800
PSC63-MVVNN00065-16	63	190	0.6	65	-4°	-13°	VN.. 1604..	1,070
PSC80-MVVNN00080-16	80	250	0.6	80	-4°	-13°	VN.. 1604..	2,320

Reference Bezeichnung						Nm
PSC40-MVVNN00062-16	2604	1085	5025	IVSN-322	1665 5002	2.0
PSC50-MVVNN00065-16	2604	1085	5025	IVSN-322	1665 5002	2.0
PSC63-MVVNN00065-16	2604	1085	5025	IVSN-322	1665 5002	2.0
PSC80-MVVNN00080-16	2604	1085	5025	IVSN-322	1665 5002	2.0

VN..	35° rhombic negative inserts. 35° rhombische negative Wendeschneidplatten.  A49		
Reference / Bez.	l	s	d
VN.. 1604..	16,50	4,76	9,52

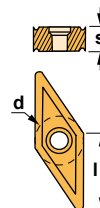

VNGP	VNMG
	
VNMG-TC	
	





Characteristics:
Multipurpose toolholder equipped with trigon negative double-sided insert (angle 80°).
PSC with internal coolant.

- 1) γ = Rake angle (valid with a flat insert).
- 2) λ_s = Angle of inclination.

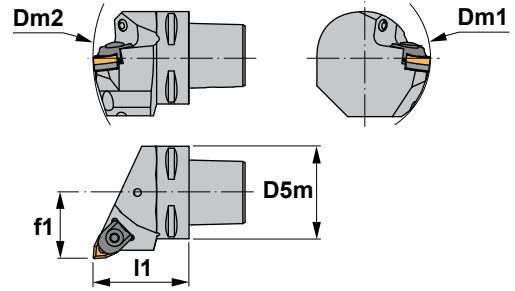

Eigenschaften:
Multifunktions-Klemmhalter mit einer doppelseitigen negativen Trigon-Wendeschneidplatte (Winkel 80°).
PSC mit Innenkühlung.

- 1) γ = Spanwinkel (Gültig nur mit flachen Wendeschneidplatte).
- 2) λ_s = Neigungswinkel.

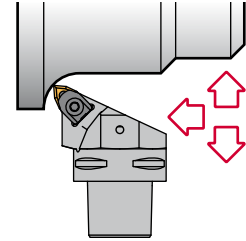

MWLN 95°

Reference Bezeichnung	D5m	Dm1 min.	Dm2 min.	f1	l1	γ 1)	λ_s 2)	Insert size Wendeschneidplatte	
PSC32-MWLNR/L22040-06	32	60	116	22	40	-6°	-6°	WNMG 0604..	0,210
PSC40-MWLNR/L27050-06	40	60	140	27	50	-6°	-6°	WNMG 0604..	0,420
PSC40-MWLNR/L27050-08	40	110	140	27	50	-6°	-6°	WNMG 0804..	0,420
PSC50-MWLNR/L35060-08	50	110	165	35	60	-6°	-6°	WNMG 0804..	0,800
PSC63-MWLNR/L45065-08	63	110	190	45	65	-6°	-6°	WNMG 0804..	1,100
PSC80-MWLNR/L55080-08	80	110	250	55	80	-6°	-6°	WNMG 0804..	2,740

Reference Bezeichnung						Nm
PSC32-MWLNR/L22040-06	2006	5025	3006	1644	1813	2.0
PSC40-MWLNR/L27050-06	2006	5025	3006	1642	1393	2.0
PSC40-MWLNR/L27050-08	2011	5005	IWSN-433	1661	1394	4.0
PSC50-MWLNR/L35060-08	2011	5005	IWSN-433	1661	1394	4.0
PSC63-MWLNR/L45065-08	2011	5005	IWSN-433	1661	1394	4.0
PSC80-MWLNR/L55080-08	2011	5005	IWSN-433	1661	1394	4.0

WNMG 80° trigon negative inserts. A50-51 80° trigon negative Wendeschneidplatten.

Reference / Bez.	l	s	d
WNMG 0604..	6,45	4,76	9,52
WNMG 0804..	8,14	4,76	12,70

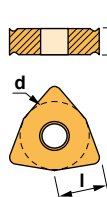



Characteristics:
Multipurpose toolholder equipped with rhombic negative double-sided insert (angle 80°). PSC with internal coolant.

- 1) γ = Rake angle (valid with a flat insert).
- 2) λ_s = Angle of inclination.

Eigenschaften:
Multifunktions-Klemmhalter mit einer doppelseitigen rhombischen Wendeschneidplatte (Winkel 80°). PSC mit Innenkühlung.

- 1) γ = Spanwinkel (Gültig nur mit flachen Wendeschneidplatte).
- 2) λ_s = Neigungswinkel.

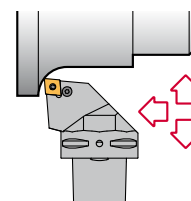
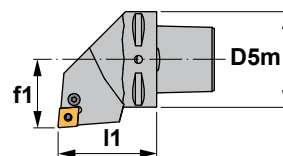
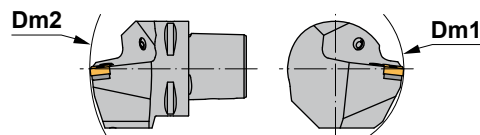

PCLN 95°

Reference Bezeichnung	D5m	Dm1 min.	Dm2 min.	f1	l1	γ^1	λ_s^2	Insert size Wendeschneidplatte	
PSC32-PCLNR/L22040-12	32	60	124	22	40	-6°	-6°	CN.. 1204..	0,210
PSC40-PCLNR/L27050-12	40	110	140	27	50	-6°	-6°	CN.. 1204..	0,420
PSC50-PCLNR/L35060-12	50	110	165	35	60	-6°	-6°	CN.. 1204..	0,800
PSC63-PCLNR/L45065-12	63	110	190	45	65	-6°	-6°	CN.. 1204..	1,100
PSC80-PCLNR/L55080-12	80	110	250	55	80	-6°	-6°	CN.. 1204..	2,740
PSC40-PCLNR/L27050-16	40	125	140	27	50	-6°	-6°	CN.. 1606..	0,420
PSC50-PCLNR/L35060-16	50	125	165	35	60	-6°	-6°	CN.. 1606..	0,800
PSC63-PCLNR/L45065-16	63	125	190	45	65	-6°	-6°	CN.. 1606..	1,100
PSC80-PCLNR/L55080-16	80	125	250	55	80	-6°	-6°	CN.. 1606..	2,740
PSC50-PCLNR/L35060-19	50	125	165	35	60	-6°	-6°	CN.. 1906..	0,800
PSC63-PCLNR/L45065-19	63	125	190	45	65	-6°	-6°	CN.. 1906..	1,100
PSC80-PCLNR/L55080-19	80	125	250	55	80	-6°	-6°	CN.. 1906..	2,740
PSC80-PCLNR/L55080-25	80	150	250	55	80	-6°	-6°	CN.. 2509..	2,740

Reference Bezeichnung							Nm
PSC32-PCLNR/L22040-12	8012	1608	5003	3612	4112	0012	3.0
PSC40-PCLNR/L27050-12	8012	1608	5003	3612	4112	0012	3.0
PSC50-PCLNR/L35060-12	8012	1608	5003	3612	4112	0012	3.0
PSC63-PCLNR/L45065-12	8012	1608	5003	3612	4112	0012	3.0
PSC80-PCLNR/L55080-12	8012	1608	5003	3612	4112	0012	3.0
PSC40-PCLNR/L27050-16	8016	1618	5003	3616	4115	0015	3.0
PSC50-PCLNR/L35060-16	8016	1618	5003	3616	4115	0015	3.0
PSC63-PCLNR/L45065-16	8016	1618	5003	3616	4115	0015	3.0
PSC80-PCLNR/L55080-16	8016	1618	5003	3616	4115	0015	3.0
PSC50-PCLNR/L35060-19	8019	1610	5004	3619	4119	0019	3.5
PSC63-PCLNR/L45065-19	8019	1610	5004	3619	4119	0019	3.5
PSC80-PCLNR/L55080-19	8019	1610	5004	3619	4119	0019	3.5
PSC80-PCLNR/L55080-25	8025	1612	5005	3625	4125	0025	4.0

CN.. 80° rhombic negative inserts. 80° rhombische negative WSP. A32-34

Reference / Bez.	l	s	d
CN.. 1204..	12,90	4,76	12,70
CN.. 1606..	16,10	6,35	15,88
CN.. 1906..	19,30	6,35	19,05
CN.. 2509..	25,80	9,52	25,40

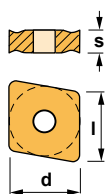

CNMG-CC CNMG-FC CNMG-FMC CNMG-KC CNMG-MC



CNMG-MFC CNMG-MHC CNMG-RC CNMG-TC CNMM





Characteristics:
Multipurpose toolholder equipped with rhombic negative double-sided insert (angle 80°).
PSC with internal coolant.

- 1) γ = Rake angle (valid with a flat insert).
- 2) λ_s = Angle of inclination.

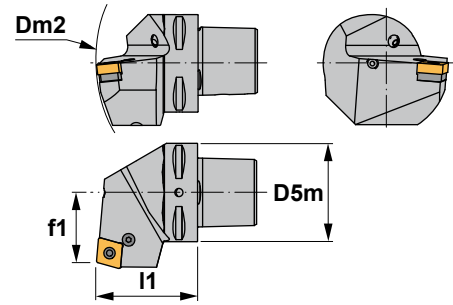

Eigenschaften:
Multifunktions-Werkzeuge mit einer doppelseitigen rhombischen negativen Wendeschneidplatte (Winkel 80°).
PSC mit Innenkühlung.

- 1) γ = Spanwinkel (Gültig nur mit flachen Wendeschneidplatte).
- 2) λ_s = Neigungswinkel.

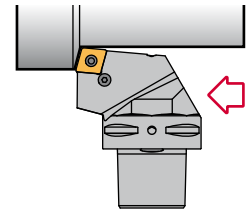

PCRN 75°

Reference Bezeichnung	D5m	Dm2 min.	f1	l1	γ^1	λ_s^2	Insert size Wendeschneidplatte	
PSC50-PCRN/L27060-12	50	165	27	60	-6°	-6°	CN.. 1204..	0,800
PSC63-PCRN/L35065-12	63	190	35	65	-6°	-6°	CN.. 1204..	1,400
PSC50-PCRN/L27060-16	50	165	27	60	-6°	-6°	CN.. 1606..	0,800
PSC63-PCRN/L35065-16	63	190	35	65	-6°	-6°	CN.. 1606..	1,400
PSC50-PCRN/L27060-19	50	165	27	60	-6°	-6°	CN.. 1906..	0,800
PSC63-PCRN/L35065-19	63	190	35	65	-6°	-6°	CN.. 1906..	1,400

Reference Bezeichnung							Nm
PSC50-PCRN/L27060-12	8012	1608	5003	3612	4112	0012	3.0
PSC63-PCRN/L35065-12	8012	1608	5003	3612	4112	0012	3.0
PSC50-PCRN/L27060-16	8016	1618	5003	3616	4115	0015	3.0
PSC63-PCRN/L35065-16	8016	1618	5003	3616	4115	0015	3.0
PSC50-PCRN/L27060-19	8019	1610	5004	3619	4119	0019	3.5
PSC63-PCRN/L35065-19	8019	1610	5004	3619	4119	0019	3.5

CN.. 80° rhombic negative inserts. 80° rhombische negative WSP. A32-34

Reference / Bez.	l	s	d
CN.. 1204..	12,90	4,76	12,70
CN.. 1606..	16,10	6,35	15,88
CN.. 1906..	19,30	6,35	19,05

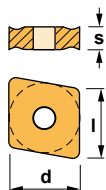



Characteristics:
Turning and profiling toolholder equipped with rhombic negative double-sided insert (angle 55°).
PSC with internal coolant.

- 1) γ = Rake angle (valid with a flat insert).
- 2) λ_s = Angle of inclination.

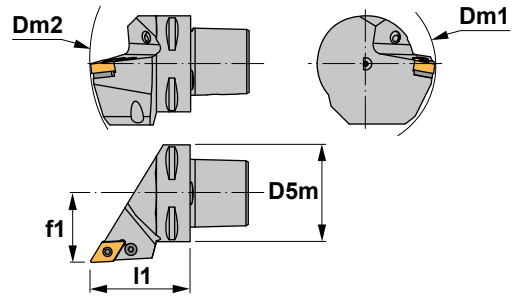

Eigenschaften:
Klemmhalter zum Drehen und Kopierdrehen mit einer doppelseitigen rhombischen negativen Wendeschneidplatte (Winkel 55°).
PSC mit Innenkühlung.

- 1) γ = Spanwinkel (Gültig nur mit flachen Wendeschneidplatte).
- 2) λ_s = Neigungswinkel.

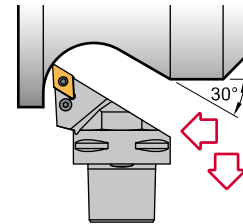

PDJN 93°

Reference Bezeichnung	D5m	Dm1 min.	Dm2 min.	f1	l1	γ^1	λ_s^2	Insert size Wendeschneidplatte	Kg
PSC50-PDJNR/L35060-11	50	110	165	35	60	-6°	-7°	DN.. 1104..	0,800
PSC40-PDJNR/L27055-15	40	110	145	27	55	-6°	-7°	DN.. 1506..	0,430
PSC50-PDJNR/L35060-15	50	110	165	35	60	-6°	-7°	DN.. 1506..	0,800
PSC63-PDJNR/L45065-15	63	110	190	45	65	-6°	-7°	DN.. 1506..	1,100
PSC80-PDJNR/L55080-15	80	110	250	55	80	-6°	-7°	DN.. 1506..	2,740

Reference Bezeichnung									Nm
PSC50-PDJNR/L35060-11	8009	1606	5025	3711	4109	0009	-	-	2.0
PSC40-PDJNR/L27055-15	8415	1638	5003	3715	4112	0012	3725	4135	3.0
PSC50-PDJNR/L35060-15	8415	1638	5003	3715	4112	0012	3725	4135	3.0
PSC63-PDJNR/L45065-15	8415	1638	5003	3715	4112	0012	3725	4135	3.0
PSC80-PDJNR/L55080-15	8415	1638	5003	3715	4112	0012	3725	4135	3.0

For inserts DNM.. 1504..
Für Wendeschneidplatten DNM.. 1504

DN..	55° rhombic negative inserts. 55° rhombische negative Wendeschneidplatten. A36-37		
Reference / Bez.	l	s	d
DN.. 1104..	11,60	4,76	9,52
DN.. 1504..	15,50	4,76	12,70
DN.. 1506..	15,50	6,35	12,70

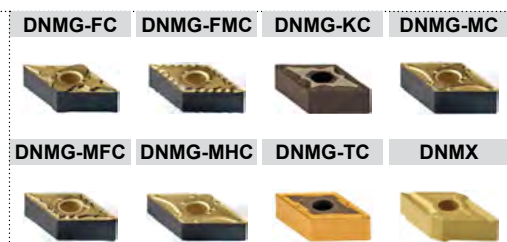
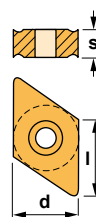



Characteristics:
Turning and profiling toolholder equipped with rhombic negative double-sided insert (angle 55°).
PSC with internal coolant.

- 1) γ = Rake angle (valid with a flat insert).
- 2) λ_s = Angle of inclination.

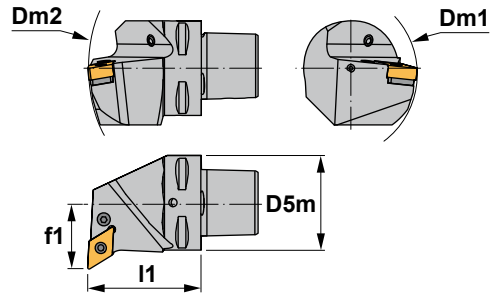

Eigenschaften:
Klemmhalter zum Drehen und Profildrehen mit einer doppelseitigen rhombischen negativen Wendeschneidplatte (Winkel 55°).
PSC mit Innenkühlung.

- 1) γ = Spanwinkel (Gültig nur mit flachen Wendeschneidplatte).
- 2) λ_s = Neigungswinkel.

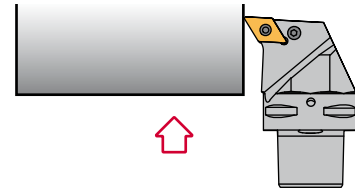

PDUN 93°

Reference Bezeichnung	D5m	Dm1 min.	Dm2 min.	f1	l1	γ^1	λ_s^2	Insert size Wendeschneidplatte	
PSC40-PDUNR/L27050-15	40	110	140	27	50	-6°	-7°	DN.. 1506..	0,420
PSC50-PDUNR/L35060-15	50	110	165	35	60	-6°	-7°	DN.. 1506..	0,800
PSC63-PDUNR/L45065-15	63	110	190	45	65	-6°	-7°	DN.. 1506..	1,100
PSC80-PDUNR/L55080-15	80	110	250	55	80	-6°	-7°	DN.. 1506..	2,740

Reference Bezeichnung									Nm
PSC40-PDUNR/L27050-15	8415	1638	5003	3715	4112	0012	3725	4135	3.0
PSC50-PDUNR/L35060-15	8415	1638	5003	3715	4112	0012	3725	4135	3.0
PSC63-PDUNR/L45065-15	8415	1638	5003	3715	4112	0012	3725	4135	3.0
PSC80-PDUNR/L55080-15	8415	1638	5003	3715	4112	0012	3725	4135	3.0

For inserts DNM.. 1504..
Für Wendeschneidplatten DNM.. 1504

DN.. 55° rhombic negative inserts. A36-37
55° rhombische negative Wendeschneidplatten.

Reference / Bez.	l	s	d
DN.. 1506..	15,50	6,35	12,70

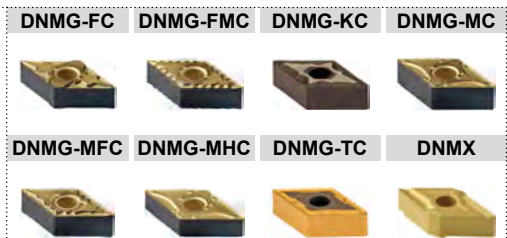
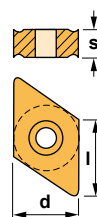



Characteristics:

Profiling toolholder equipped with round positive insert. PSC with internal coolant.

- 1) γ = Rake angle (valid with a flat insert).
- 2) λ_s = Angle of inclination.

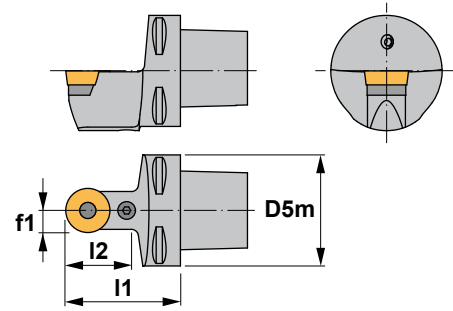

Eigenschaften:

Klemmhalter zum Profildrehen mit einer runden positiven Wendeschneidplatte.
PSC mit Innenkühlung.

- 1) γ = Spanwinkel (Gültig nur mit flachen Wendeschneidplatte).
- 2) λ_s = Neigungswinkel.

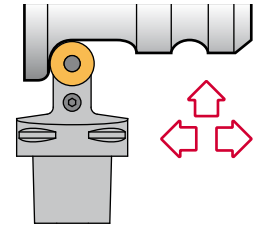

PRDC

Reference Bezeichnung	D5m	f1	l1	γ^1	λ_s^2	l2	Insert size Wendeschneidplatte	
PSC63-PRDCN00065-25	63	12.5	65	0°	0°	40	RC.. 2507M0	1,070
PSC80-PRDCN00080-25	80	12.5	80	0°	0°	40	RC.. 2507M0	2,320
PSC80-PRDCN00080-32	80	16.0	80	0°	0°	45	RC.. 3209M0	2,320

Reference Bezeichnung							Nm
PSC63-PRDCN00065-25	8125	1710	5004	3825	4119	0019	3.5
PSC80-PRDCN00080-25	8125	1710	5004	3825	4119	0019	3.5
PSC80-PRDCN00080-32	8132	1612	5005	3832	4125	0025	4.0

RC..

Round positive inserts with 7° clearance. A38-39
Runde positive Wendeschneidplatten mit 7° Freiwinkel.

Reference / Bez.	s	d
RC.. 2507M0	7,94	25,00
RC.. 3209M0	9,52	32,00

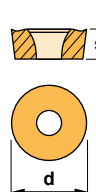

RCGT-AL



RCGT-AP



RCMT



**Characteristics:**

Profiling toolholder equipped with round positive insert. PSC with internal coolant.

- 1) γ = Rake angle (valid with a flat insert).
- 2) λs = Angle of inclination.

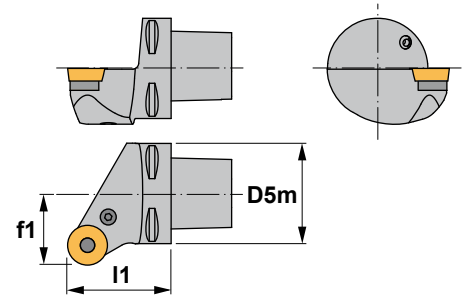
**Eigenschaften:**





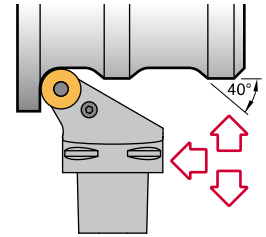

Klemmhalter zum Profildrehen mit einer runden positiven Wendeschneidplatten. PSC mit Innenkühlung.

- 1) γ = Spanwinkel (Gültig nur mit flachen Wendeschneidplatte).
- 2) λs = Neigungswinkel.



PRSC

Reference Bezeichnung	D5m	f1	l1	γ^1	λs^2	Insert size Wendeschneidplatte	
PSC80-PRSCR/L55080-20	80	55	80	0°	0°	RC.. 2006M0	2,740
PSC63-PRSCR/L45065-25	63	45	65	0°	0°	RC.. 2507M0	1,100
PSC80-PRSCR/L55080-25	80	55	80	0°	0°	RC.. 2507M0	2,740
PSC80-PRSCR/L55080-32	80	55	80	0°	0°	RC.. 3209M0	2,740

Reference Bezeichnung							Nm
PSC80-PRSCR/L55080-20	8120	1708	5003	3820	4115	0015	3.0
PSC63-PRSCR/L45065-25	8125	1710	5004	3825	4119	0019	3.5
PSC80-PRSCR/L55080-25	8125	1710	5004	3825	4119	0019	3.5
PSC80-PRSCR/L55080-32	8132	1612	5005	3832	4125	0025	4.0

RC..

Round positive inserts with 7° clearance.  A38-39
Runde positive Wendeschneidplatten mit 7° Freiwinkel.

Reference / Bez.	s	d
RC.. 2006M0	6,35	20,00
RC.. 2507M0	7,94	25,00
RC.. 3209M0	9,52	32,00

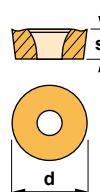
**RCGT-AL****RCGT-AP****RCMT**



Characteristics:

Toolholder for external turning and chamfering applications equipped with square negative inserts.

PSC with internal coolant.

- 1) γ = Rake angle (valid with a flat insert).
- 2) λ_s = Angle of inclination.

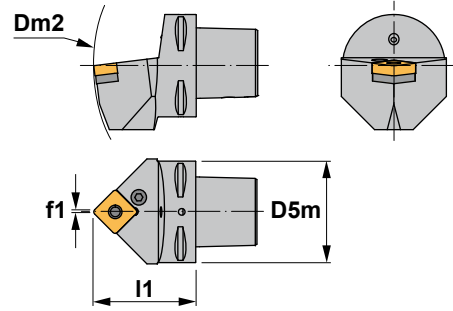

Eigenschaften:

Klemmhalter zum Außendreihen und Abschrägen mit einer vierkantigen negativen Wendeschneidplatte.

PSC mit Innenkühlung.

- 1) γ = Spanwinkel (Gültig nur mit flachen Wendeschneidplatte).
- 2) λ_s = Neigungswinkel.

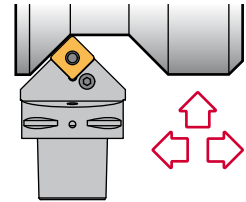

PSDN 45°

Reference Bezeichnung	D5m	Dm2 min.	f1	l1	γ 1)	λ_s 2)	Insert size Wendeschneidplatte	KG
PSC40-PSDNN00050-12	40	140	0.3	50	-6°	-6°	SNM.. 1204..	0,350
PSC50-PSDNN00060-12	50	165	0.3	60	-6°	-6°	SNM.. 1204..	0,750
PSC63-PSDNN00065-12	63	190	0.3	65	-6°	-6°	SNM.. 1204..	1,070
PSC40-PSDNN00050-15	40	140	0.5	50	-6°	-6°	SNM.. 1506..	0,350
PSC50-PSDNN00060-15	50	165	0.5	60	-6°	-6°	SNM.. 1506..	0,750
PSC63-PSDNN00065-15	63	190	0.5	65	-6°	-6°	SNM.. 1506..	1,070
PSC50-PSDNN00060-19	50	170	0.5	60	-6°	-6°	SNM.. 1906..	0,750
PSC63-PSDNN00065-19	63	195	0.5	65	-6°	-6°	SNM.. 1906..	1,070
PSC63-PSDNN00065-25	63	195	1.0	65	-6°	-6°	SNM.. 2507..	1,070
PSC80-PSDNN00080-25	80	250	1.0	80	-6°	-6°	SNM.. 2507..	2,320

Reference Bezeichnung							Nm
PSC40-PSDNN00050-12	8012	1608	5003	3512	4112	0012	3.0
PSC50-PSDNN00060-12	8012	1608	5003	3512	4112	0012	3.0
PSC63-PSDNN00065-12	8012	1608	5003	3512	4112	0012	3.0
PSC40-PSDNN00050-15	8016	1618	5003	3515	4115	0015	3.0
PSC50-PSDNN00060-15	8016	1618	5003	3515	4115	0015	3.0
PSC63-PSDNN00065-15	8016	1618	5003	3515	4115	0015	3.0
PSC50-PSDNN00060-19	8019	1610	5004	3519	4119	0019	3.5
PSC63-PSDNN00065-19	8019	1610	5004	3519	4119	0019	3.5
PSC63-PSDNN00065-25	8025	1612	5005	3525	4125	0025	4.0
PSC80-PSDNN00080-25	8025	1612	5005	3525	4125	0025	4.0

SNM.. Square negative inserts. Vierkantige negative Wendeschneidplatten. A41-42

Reference / Bez.	l	s	d
SNM.. 1204..	12,70	4,76	12,70
SNM.. 1506..	15,88	6,35	15,88
SNM.. 1906..	19,05	6,35	19,05
SNM.. 2507..	25,40	7,94	25,40

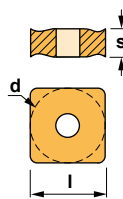

SNMG-FMC	SNMG-KC	SNMG-MHC
SNMG-RC	SNMG-TC	SNMM





Characteristics:
Toolholder for face turning applications equipped with square negative inserts.
PSC with internal coolant.

- 1) γ = Rake angle (valid with a flat insert).
- 2) λ_s = Angle of inclination.

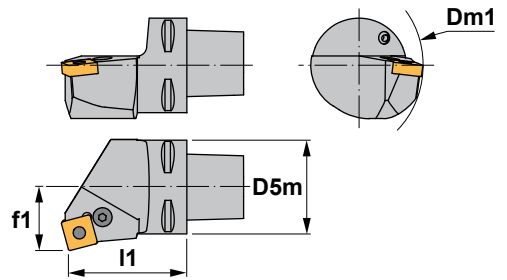

Eigenschaften:
Klemmhalter zum Plandrehen mit einer vierkantigen negativen Wendeschneidplatte.
PSC mit Innenkühlung.

- 1) γ = Spanwinkel (Gültig nur mit flachen Wendeschneidplatte).
- 2) λ_s = Neigungswinkel.

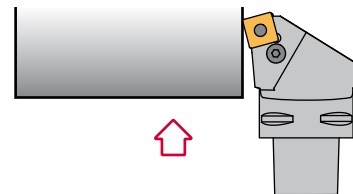

PSKN 75°

Reference Bezeichnung	D5m	Dm1 min.	f1	l1	γ^1	λ_s^2	Insert size Wendeschneidplatte	Kg
PSC40-PSKNR/L27050-12	40	110	27	50	-6°	-6°	SNM.. 1204..	0,420
PSC50-PSKNR/L35060-12	50	110	35	60	-6°	-6°	SNM.. 1204..	0,800
PSC63-PSKNR/L45065-12	63	110	45	65	-6°	-6°	SNM.. 1204..	1,100
PSC50-PSKNR/L35060-15	50	125	35	60	-6°	-6°	SNM.. 1506..	0,800
PSC63-PSKNR/L45065-15	63	125	45	65	-6°	-6°	SNM.. 1506..	1,100
PSC50-PSKNR/L35060-19	50	125	35	60	-6°	-6°	SNM.. 1906..	0,800
PSC63-PSKNR/L45065-19	63	125	45	65	-6°	-6°	SNM.. 1906..	1,100
PSC80-PSKNR/L55080-19	80	125	55	80	-6°	-6°	SNM.. 1906..	2,740
PSC80-PSKNR/L55080-25	80	150	55	80	-6°	-6°	SNM.. 2507..	2,740

Reference Bezeichnung							Nm
PSC40-PSKNR/L27050-12	8012	1608	5003	3512	4112	0012	3.0
PSC50-PSKNR/L35060-12	8012	1608	5003	3512	4112	0012	3.0
PSC63-PSKNR/L45065-12	8012	1608	5003	3512	4112	0012	3.0
PSC50-PSKNR/L35060-15	8016	1618	5003	3515	4115	0015	3.0
PSC63-PSKNR/L45065-15	8016	1618	5003	3515	4115	0015	3.0
PSC50-PSKNR/L35060-19	8019	1610	5004	3519	4119	0019	3.5
PSC63-PSKNR/L45065-19	8019	1610	5004	3519	4119	0019	3.5
PSC80-PSKNR/L55080-19	8019	1610	5004	3519	4119	0019	3.5
PSC80-PSKNR/L55080-25	8025	1612	5005	3525	4125	0025	4.0

SNM.. Square negative inserts. Vierkantige negative Wendeschneidplatten. A41-42

Reference / Bez.	l	s	d
SNM.. 1204..	12,70	4,76	12,70
SNM.. 1506..	15,88	6,35	15,88
SNM.. 1906..	19,05	6,35	19,05
SNM.. 2507..	25,40	7,94	25,40

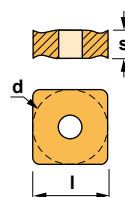



Characteristics:
Toolholder for face turning applications equipped with square negative inserts.
PSC with internal coolant.

- 1) γ = Rake angle (valid with a flat insert).
- 2) λ_s = Angle of inclination.

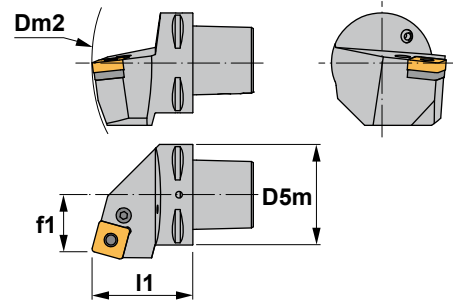

Eigenschaften:
Klemmhalter zum Plandrehen mit einer vierkantigen negativen Wendeschneidplatte.
PSC mit Innenkühlung.

- 1) γ = Spanwinkel (Gültig nur mit flachen Wendeschneidplatte).
- 2) λ_s = Neigungswinkel.

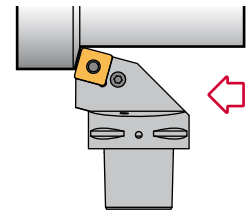

PSRN 75°

Reference Bezeichnung	D5m	Dm2 min.	f1	l1	γ^1	λ_s^2	Insert size Wendeschneidplatte	
PSC32-PSRNR/L17040-12	32	124	17	40	-6°	-6°	SNM.. 1204..	0,200
PSC40-PSRNR/L22050-12	40	140	22	50	-6°	-6°	SNM.. 1204..	0,420
PSC50-PSRNR/L27060-12	50	165	27	60	-6°	-6°	SNM.. 1204..	0,800
PSC63-PSRNR/L35065-12	63	190	35	65	-6°	-6°	SNM.. 1204..	1,400
PSC50-PSRNR/L27060-15	50	165	27	60	-6°	-6°	SNM.. 1506..	0,800
PSC63-PSRNR/L35065-15	63	190	35	65	-6°	-6°	SNM.. 1506..	1,400
PSC50-PSRNR/L27060-19	50	165	27	60	-6°	-6°	SNM.. 1906..	0,800
PSC63-PSRNR/L35065-19	63	190	35	65	-6°	-6°	SNM.. 1906..	1,400
PSC80-PSRNR/L45080-19	80	250	45	80	-6°	-6°	SNM.. 1906..	2,800
PSC80-PSRNR/L45080-25	80	250	45	80	-6°	-6°	SNM.. 2507..	2,800

Reference Bezeichnung							Nm
PSC32-PSRNR/L17040-12	8012	1608	5003	3512	4112	0012	3.0
PSC40-PSRNR/L22050-12	8012	1608	5003	3512	4112	0012	3.0
PSC50-PSRNR/L27060-12	8012	1608	5003	3512	4112	0012	3.0
PSC63-PSRNR/L35065-12	8012	1608	5003	3512	4112	0012	3.0
PSC50-PSRNR/L27060-15	8016	1618	5003	3515	4115	0015	3.0
PSC63-PSRNR/L35065-15	8016	1618	5003	3515	4115	0015	3.0
PSC50-PSRNR/L27060-19	8019	1610	5004	3519	4119	0019	3.5
PSC63-PSRNR/L35065-19	8019	1610	5004	3519	4119	0019	3.5
PSC80-PSRNR/L45080-19	8019	1610	5004	3519	4119	0019	3.5
PSC80-PSRNR/L45080-25	8025	1612	5005	3525	4125	0025	4.0

SNM.. Square negative inserts. Vierkantige negative Wendeschneidplatten. A41-42

Reference / Bez.	l	s	d
SNM.. 1204..	12,70	4,76	12,70
SNM.. 1506..	15,88	6,35	15,88
SNM.. 1906..	19,05	6,35	19,05
SNM.. 2507..	25,40	7,94	25,40

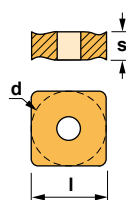

SNMG-FMC SNMG-KC SNMG-MHC



SNMG-RC



SNMG-TC



SNMM





Characteristics:
Toolholder for external turning and chamfering applications equipped with square negative inserts.
PSC with internal coolant.

- 1) γ = Rake angle (valid with a flat insert).
- 2) λ_s = Angle of inclination.

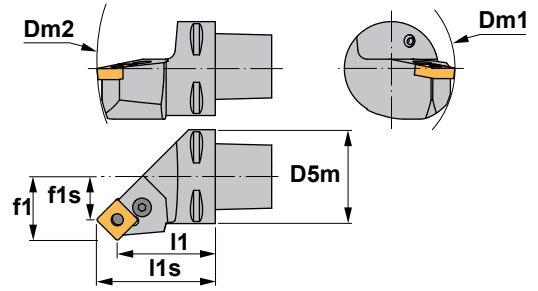

Eigenschaften:
Klemmhalter zum Außendreihen und Abschrägen mit einer vierkantigen negativen Wendeschneidplatte.
PSC mit Innenkühlung.

- 1) γ = Spanwinkel (Gültig nur mit flachen Wendeschneidplatte).
- 2) λ_s = Neigungswinkel.

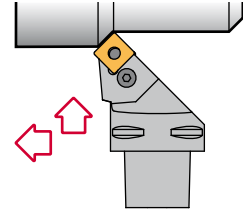

PSSN 45°

Reference Bezeichnung	D5m	Dm1 min.	Dm2 min.	f1	f1s	l1	l1s	γ^1	λ_{s2}	Insert size Wendeschneidplatte	kg
PSC32-PSSNR/L22032-12	32	60	124	22	13.7	32	40.3	-8°	0°	SNM.. 1204..	0,180
PSC40-PSSNR/L27042-12	40	110	140	27	18.7	42	50.3	-8°	0°	SNM.. 1204..	0,350
PSC50-PSSNR/L35052-12	50	110	165	35	26.7	52	60.3	-8°	0°	SNM.. 1204..	0,700
PSC63-PSSNR/L45056-12	63	110	190	45	36.7	56	64.3	-8°	0°	SNM.. 1204..	1,120
PSC63-PSSNR/L45054-15	63	125	190	45	34.8	54	64.2	-8°	0°	SNM.. 1506..	1,140
PSC63-PSSNR/L45052-19	63	125	190	45	32.5	52	64.5	-8°	0°	SNM.. 1906..	1,130
PSC80-PSSNR/L55070-25	80	150	256	55	39.0	70	86.0	-8°	0°	SNM.. 2507..	2,620

Reference Bezeichnung							Nm
PSC32-PSSNR/L22032-12	8012	1608	5003	3512	4112	0012	3.0
PSC40-PSSNR/L27042-12	8012	1608	5003	3512	4112	0012	3.0
PSC50-PSSNR/L35052-12	8012	1608	5003	3512	4112	0012	3.0
PSC63-PSSNR/L45056-12	8012	1608	5003	3512	4112	0012	3.0
PSC63-PSSNR/L45054-15	8016	1618	5003	3515	4115	0015	3.0
PSC63-PSSNR/L45052-19	8019	1610	5004	3519	4119	0019	3.5
PSC80-PSSNR/L55070-25	8025	1612	5005	3525	4125	0025	4.0

SNM.. Square negative inserts. Vierkantige negative Wendeschneidplatten. A41-42

Reference / Bez.	l	s	d
SNM.. 1204..	12,70	4,76	12,70
SNM.. 1506..	15,88	6,35	15,88
SNM.. 1906..	19,05	6,35	19,05
SNM.. 2507..	25,40	7,94	25,40

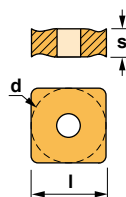

SNMG-FMC SNMG-KC SNMG-MHC



SNMG-RC SNMG-TC SNMM





Characteristics:
Multipurpose toolholder equipped with rhombic positive insert (angle 80°).
PSC with internal coolant.

- 1) γ = Rake angle (valid with a flat insert).
- 2) λ_s = Angle of inclination.

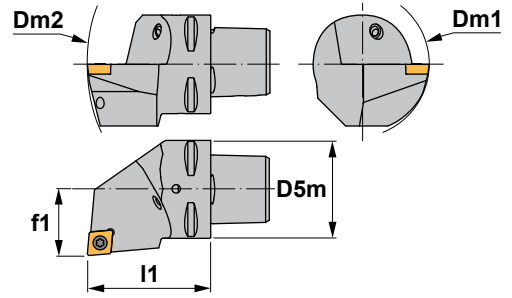

Eigenschaften:
Multifunktions-Klemmhalter mit einer rhombischen positiven Wendeschneidplatte (80° Winkel).
PSC mit Innenkühlung.

- 1) γ = Spanwinkel (Gültig nur mit flachen Wendeschneidplatte).
- 2) λ_s = Neigungswinkel.

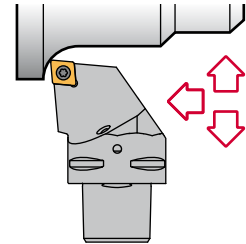

SCLC 95°

Reference Bezeichnung	D5m	Dm1 min.	Dm2 min.	f1	l1	γ^1	λ_s^2	Insert size Wendeschneidplatte	
PSC32-SCLCR/L22040-09	32	80	124	22	40	0°	0°	CC.. 09T3..	0,210
PSC40-SCLCR/L27050-09	40	80	140	27	50	0°	0°	CC.. 09T3..	0,420
PSC50-SCLCR/L35060-09	50	80	165	35	60	0°	0°	CC.. 09T3..	0,800
PSC63-SCLCR/L45065-09	63	80	190	45	65	0°	0°	CC.. 09T3..	1,100
PSC32-SCLCR/L22040-12	32	110	124	22	40	0°	0°	CC.. 1204..	0,210
PSC40-SCLCR/L27050-12	40	110	140	27	50	0°	0°	CC.. 1204..	0,420
PSC50-SCLCR/L35060-12	50	110	165	35	60	0°	0°	CC.. 1204..	0,800
PSC63-SCLCR/L45065-12	63	110	190	45	65	0°	0°	CC.. 1204..	1,100

Reference Bezeichnung					Nm
PSC32-SCLCR/L22040-09	1240	5515	-	-	3.0
PSC40-SCLCR/L27050-09	1240	5515	-	-	3.0
PSC50-SCLCR/L35060-09	1240	5515	-	-	3.0
PSC63-SCLCR/L45065-09	1240	5515	-	-	3.0
PSC32-SCLCR/L22040-12	1540	5517	3614	1760	3.0
PSC40-SCLCR/L27050-12	1540	5517	3614	1760	3.0
PSC50-SCLCR/L35060-12	1540	5517	3614	1760	3.0
PSC63-SCLCR/L45065-12	1540	5517	3614	1760	3.0

CC.. 80° rhombic positive inserts with 7° clearance. A30-31
80° rhombische positive Wendeschneidplatten mit 7° Freiwinkel.

Reference / Bez.	l	s	d
CC.. 09T3..	9,65	3,97	9,52
CC.. 1204..	12,90	4,76	12,70

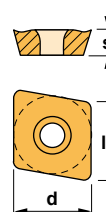

CCGT-AL



CCGT-AP



CCMT



CCMW





Characteristics:
Multipurpose toolholder equipped with rhombic positive insert (angle 55°).
PSC with internal coolant.

- 1) γ = Rake angle (valid with a flat insert).
- 2) λ_s = Angle of inclination.

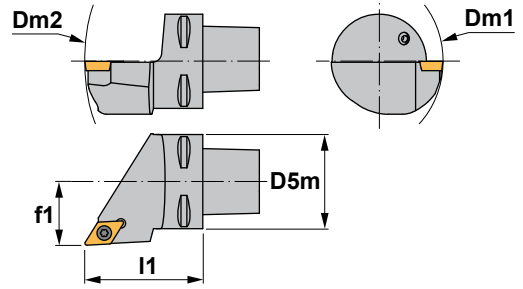

Eigenschaften:
Multifunktions-Klemmhalter mit einer rhombischen positiven Wendeschneidplatte (55° Winkel).
PSC mit Innenkühlung.

- 1) γ = Spanwinkel (Gültig nur mit flachen Wendeschneidplatte).
- 2) λ_s = Neigungswinkel.

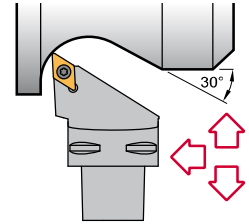

SDJC 93°

Reference Bezeichnung	D5m	Dm1 min.	Dm2 min.	f1	l1	γ^1	λ_s^2	Insert size Wendeschneidplatte	
PSC32-SDJCR/L22040-07	32	80	124	22	40	0°	0°	DC.. 0702..	0,210
PSC40-SDJCR/L27050-07	40	80	140	27	50	0°	0°	DC.. 0702..	0,420
PSC32-SDJCR/L22040-11	32	110	124	22	40	0°	0°	DC.. 11T3..	0,210
PSC40-SDJCR/L27050-11	40	110	140	27	50	0°	0°	DC.. 11T3..	0,420
PSC50-SDJCR/L35060-11	50	110	165	35	60	0°	0°	DC.. 11T3..	0,800
PSC63-SDJCR/L45065-11	63	110	190	45	65	0°	0°	DC.. 11T3..	1,100

Reference Bezeichnung					Nm
PSC32-SDJCR/L22040-07	1225	5507	-	-	0.9
PSC40-SDJCR/L27050-07	1225	5507	-	-	0.9
PSC32-SDJCR/L22040-11	1335	5516	3714	1750	3.0
PSC40-SDJCR/L27050-11	1335	5516	3714	1750	3.0
PSC50-SDJCR/L35060-11	1335	5516	3714	1750	3.0
PSC63-SDJCR/L45065-11	1335	5516	3714	1750	3.0

DC.. 55° rhombic positive inserts with 7° clearance. A35
55° rhombische positive Wendeschneidplatten mit 7° Freiwinkel.

Reference / Bez.	l	s	d
DC.. 0702..	7,75	2,38	6,35
DC.. 11T3..	11,60	3,97	9,52

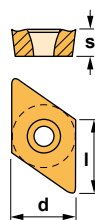

DCGT-AL



DCGT-AP



DCMT



DCMW





Characteristics:
Multipurpose profiling toolholder equipped with rhombic positive insert (angle 55°).
PSC with internal coolant.

- 1) γ = Rake angle (valid with a flat insert).
- 2) λ_s = Angle of inclination.

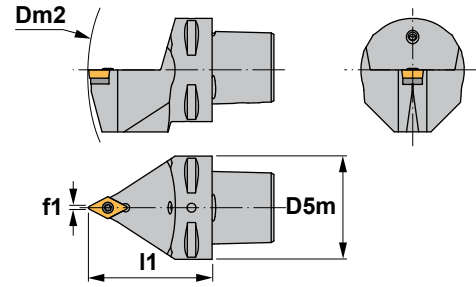

Eigenschaften:
Multifunktions-Klemmhalter zum Profildrehen mit einer rhombischen positiven Wendeschneidplatte (55° Winkel).
PSC mit Innenkühlung.

- 1) γ = Spanwinkel (Gültig nur mit flachen Wendeschneidplatte).
- 2) λ_s = Neigungswinkel.

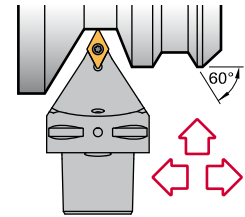

SDNC 62° 30'

Reference Bezeichnung	D5m	Dm2 min.	f1	l1	γ^1	λ_s^2	Insert size Wendeschneidplatte	Kg
PSC32-SDNCN00040-11	32	124	0.5	40	0°	0°	DC.. 11T3..	0,160
PSC40-SDNCN00050-11	40	140	0.5	50	0°	0°	DC.. 11T3..	0,350
PSC50-SDNCN00060-11	50	165	0.5	60	0°	0°	DC.. 11T3..	0,750

Reference Bezeichnung					Nm
PSC32-SDNCN00040-11	1335	5516	3714	1750	3.0
PSC40-SDNCN00050-11	1335	5516	3714	1750	3.0
PSC50-SDNCN00060-11	1335	5516	3714	1750	3.0

DC.. 55° rhombic positive inserts with 7° clearance. A35
55° rhombische positive Wendeschneidplatten mit 7° Freiwinkel.

Reference / Bez.	l	s	d
DC.. 11T3..	11,60	3,97	9,52

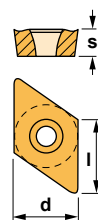

DCGT-AL



DCGT-AP



DCMT



DCMW



**Characteristics:**

Profiling toolholder equipped with round positive insert. PSC with internal coolant.

- 1) γ = Rake angle (valid with a flat insert).
2) λ_s = Angle of inclination.

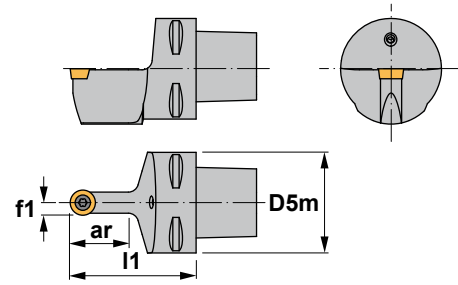
**Eigenschaften:**



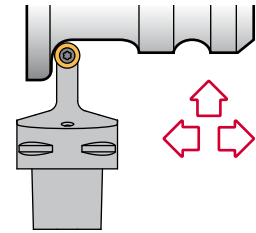

Klemmhalter zum Profildrehen mit einer runden positiven Wendeschneidplatte.
PSC mit Innenkühlung.

- 1) γ = Spanwinkel (Gültig nur mit flachen Wendeschneidplatte).
2) λ_s = Neigungswinkel.



SRDC

Reference Bezeichnung	ar	D5m	f1	l1	γ^1	λ_s^2	Insert size Wendeschneidplatte	
PSC32-SRDCN00040-06	12	32	3	40	0°	0°	RC.. 0602M0	0,160
PSC40-SRDCN00050-06	12	40	3	50	0°	0°	RC.. 0602M0	0,350
PSC50-SRDCN00060-06	12	50	3	60	0°	0°	RC.. 0602M0	0,750
PSC32-SRDCN00040-08	16	32	4	40	0°	0°	RC.. 0803M0	0,160
PSC40-SRDCN00050-08	16	40	4	50	0°	0°	RC.. 0803M0	0,350
PSC50-SRDCN00060-08	16	50	4	60	0°	0°	RC.. 0803M0	0,750
PSC32-SRDCN00040-10	20	32	5	40	0°	0°	RC.. 10T3M0	0,160
PSC40-SRDCN00050-10	25	40	5	50	0°	0°	RC.. 10T3M0	0,350
PSC50-SRDCN00060-10	25	50	5	60	0°	0°	RC.. 10T3M0	0,750
PSC63-SRDCN00065-10	25	63	5	65	0°	0°	RC.. 10T3M0	1,070
PSC40-SRDCN00050-12	28	40	6	50	0°	0°	RC.. 1204M0	0,350
PSC50-SRDCN00060-12	28	50	6	60	0°	0°	RC.. 1204M0	0,750
PSC63-SRDCN00065-12	28	63	6	65	0°	0°	RC.. 1204M0	1,070
PSC50-SRDCN00060-16	35	50	8	60	0°	0°	RC.. 1606M0	0,750
PSC63-SRDCN00065-16	35	63	8	65	0°	0°	RC.. 1606M0	1,070
PSC50-SRDCN00060-20	40	50	10	60	0°	0°	RC.. 2006M0	0,750
PSC63-SRDCN00065-20	40	63	10	65	0°	0°	RC.. 2006M0	1,070

Reference Bezeichnung					Nm
... -06	1225	5507	-	-	0.9
... -08	1230	5508	-	-	1.2
... -10	1335	5516	3811	1750	3.0
... -12	1335	5516	3814	1750	3.0
... -16	1540	5517	3816	1765	3.0
... -20	1260	5520	3919	1059	4.0

RC..

Round positive inserts with 7° clearance.  A38-39
Runde positive Wendeschneidplatten mit 7° Freiwinkel.

Reference / Bez.	s	d
RC.. 0602M0	2,38	6,00
RC.. 0803M0	3,18	8,00
RC.. 10T3M0	3,97	10,00
RC.. 1204M0	4,76	12,00
RC.. 1606M0	6,35	16,00
RC.. 2006M0	6,35	20,00

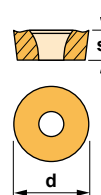
**RCGT-AL****RCGT-AP****RCMT**



Characteristics:
Profiling toolholder equipped with round positive insert. PSC with internal coolant.

- 1) γ = Rake angle (valid with a flat insert).
2) λ_s = Angle of inclination.

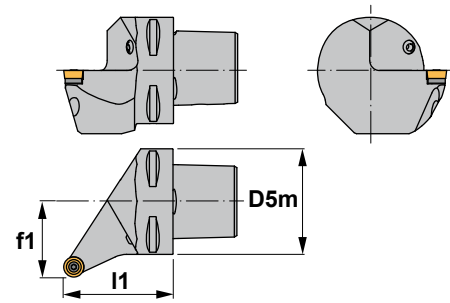

Eigenschaften:
Klemmhalter zum Profildrehen mit einer runden positiven Wendeschneidplatte.
PSC mit Innenkühlung.

- 1) γ = Spanwinkel (Gültig nur mit flachen Wendeschneidplatte).
2) λ_s = Neigungswinkel.

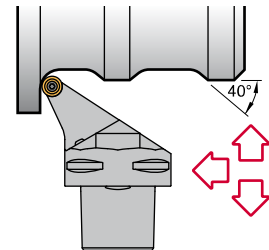

SRSC 45°

Reference Bezeichnung	D5m	f1	l1	γ^1	λ_s^2	Insert size Wendeschneidplatte	Kg
PSC32-SRSCR/L22040-06	32	22	40	0°	0°	RC.. 0602M0	0,210
PSC40-SRSCR/L27050-06	40	27	50	0°	0°	RC.. 0602M0	0,420
PSC50-SRSCR/L35060-06	50	35	60	0°	0°	RC.. 0602M0	0,800
PSC32-SRSCR/L22040-08	32	22	40	0°	0°	RC.. 0803M0	0,210
PSC40-SRSCR/L27050-08	40	27	50	0°	0°	RC.. 0803M0	0,420
PSC50-SRSCR/L35060-08	50	35	60	0°	0°	RC.. 0803M0	0,800
PSC32-SRSCR/L22040-10	32	22	40	0°	0°	RC.. 10T3M0	0,210
PSC40-SRSCR/L27050-10	40	27	50	0°	0°	RC.. 10T3M0	0,420
PSC50-SRSCR/L35060-10	50	35	60	0°	0°	RC.. 10T3M0	0,800
PSC63-SRSCR/L45065-10	63	45	65	0°	0°	RC.. 10T3M0	1,100
PSC40-SRSCR/L27050-12	40	27	50	0°	0°	RC.. 1204M0	0,420
PSC50-SRSCR/L35060-12	50	35	60	0°	0°	RC.. 1204M0	0,800
PSC63-SRSCR/L45065-12	63	45	65	0°	0°	RC.. 1204M0	1,100
PSC50-SRSCR/L35060-16	50	35	60	0°	0°	RC.. 1606M0	0,800
PSC63-SRSCR/L45065-16	63	45	65	0°	0°	RC.. 1606M0	1,100
PSC50-SRSCR/L35060-20	50	35	60	0°	0°	RC.. 2006M0	0,800
PSC63-SRSCR/L45065-20	63	45	65	0°	0°	RC.. 2006M0	1,100

Reference Bezeichnung					Nm
... -06	1225	5507	-	-	0.9
... -08	1230	5508	-	-	1.2
... -10	1335	5516	3811	1750	3.0
... -12	1335	5516	3814	1750	3.0
... -16	1540	5517	3816	1765	3.0
... -20	1260	5520	3919	1059	4.0

RC..

Round positive inserts with 7° clearance. A38-39
Runde positive Wendeschneidplatten mit 7° Freiwinkel.

Reference / Bez.	s	d
RC.. 0602M0	2,38	6,00
RC.. 0803M0	3,18	8,00
RC.. 10T3M0	3,97	10,00
RC.. 1204M0	4,76	12,00
RC.. 1606M0	6,35	16,00
RC.. 2006M0	6,35	20,00

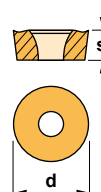

RCGT-AL

RCGT-AP



RCMT





Characteristics:

Toolholder for external turning and chamfering applications equipped with square positive inserts.
PSC with internal coolant.

- 1) γ = Rake angle (valid with a flat insert).
- 2) λ_s = Angle of inclination.

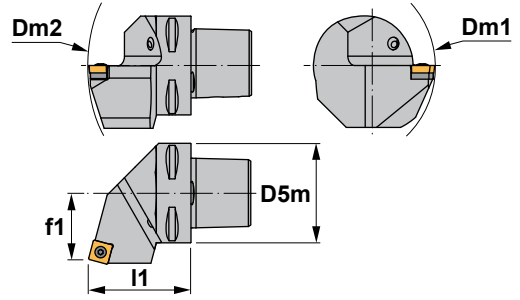

Eigenschaften:

Klemmhalter zum Außendrehen und Abschrägen mit einer vierkantigen positiven Wendeschneidplatte.
PSC mit Innenkühlung.

- 1) γ = Spanwinkel (Gültig nur mit flachen Wendeschneidplatte).
- 2) λ_s = Neigungswinkel.

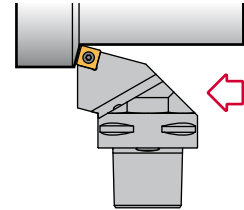

SSRC 75°

Reference Bezeichnung	D5m	Dm1 min.	Dm2 min.	f1	l1	γ^1	λ_s^2	Insert size Wendeschneidplatte	
PSC40-SSRCR/L22050-12	40	110	140	22	50	0°	0°	SC.. 1204..	0,420
PSC50-SSRCR/L27060-12	50	110	165	27	60	0°	0°	SC.. 1204..	0,800

Reference Bezeichnung					Nm
PSC40-SSRCR/L22050-12	1540	5517	3514	1760	3.0
PSC50-SSRCR/L27060-12	1540	5517	3514	1760	3.0

SC.. Square positive inserts with 7° clearance. A40
Vierkantige positive Wendeschneidplatten mit 7° Freiwinkel.

Reference / Bez.	l	s	d
SC.. 1204..	12,70	4,76	12,70

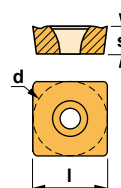

SCGT-AL



SCMT



SCMT-39





Characteristics:
Toolholder for external turning applications equipped with triangular positive inserts. PSC with internal coolant.

- 1) γ = Rake angle (valid with a flat insert).
- 2) λ_s = Angle of inclination.

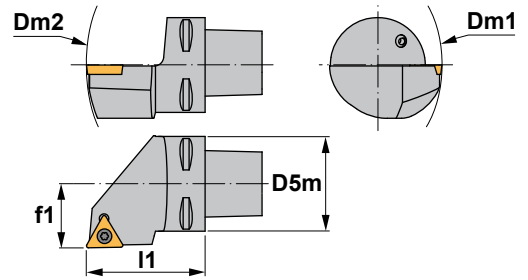

Eigenschaften:
Klemmhalter zum Außendrehen mit einer dreikantigen positiven Wendeschneidplatte. PSC mit Innenkühlung.

- 1) γ = Spanwinkel (Gültig nur mit flachen Wendeschneidplatte).
- 2) λ_s = Neigungswinkel.

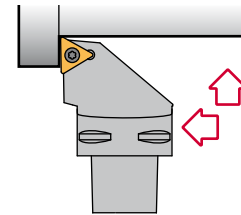

STGC 90°

Reference Bezeichnung	D5m	Dm1 min.	Dm2 min.	f1	l1	$\gamma^1)$	$\lambda_s^2)$	Insert size Wendeschneidplatte	
PSC32-STGCR/L22040-11	32	80	124	22	40	0°	0°	TC.. 1102..	0,210
PSC40-STGCR/L27050-11	40	80	140	27	50	0°	0°	TC.. 1102..	0,420
PSC32-STGCR/L22040-16	32	110	124	22	40	0°	0°	TC.. 16T3..	0,210
PSC40-STGCR/L27050-16	40	110	140	27	50	0°	0°	TC.. 16T3..	0,420
PSC50-STGCR/L35060-16	50	110	165	35	60	0°	0°	TC.. 16T3..	0,800
PSC63-STGCR/L45065-16	63	110	190	45	65	0°	0°	TC.. 16T3..	1,100

Reference Bezeichnung					Nm
PSC32-STGCR/L22040-11	1225	5507	-	-	0.9
PSC40-STGCR/L27050-11	1225	5507	-	-	0.9
PSC32-STGCR/L22040-16	1335	5516	3414	1750	3.0
PSC40-STGCR/L27050-16	1335	5516	3414	1750	3.0
PSC50-STGCR/L35060-16	1335	5516	3414	1750	3.0
PSC63-STGCR/L45065-16	1335	5516	3414	1750	3.0

TC.. Triangular positive inserts with 7° clearance. A44
Dreikantige positive Wendeschneidplatten mit 7° Freiwinkel.

Reference / Bez.	l	s	d
TC.. 1102..	11,00	2,38	6,35
TC.. 16T3..	16,50	3,97	9,52

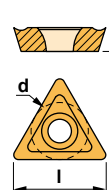

TCGT-AL



TCMT



TCMW





Characteristics:
Toolholder for external and face turning applications equipped with triangular positive inserts.
PSC with internal coolant.

- 1) γ = Rake angle (valid with a flat insert).
- 2) λ_s = Angle of inclination.

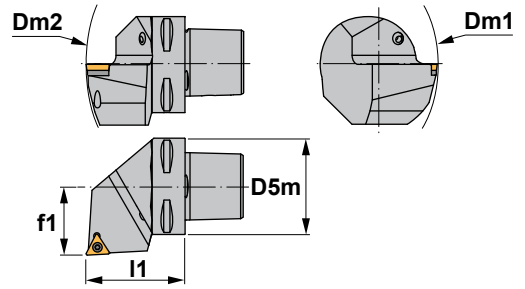

Eigenschaften:
Klemmhalter zum Außen- und Plandrehen mit einer dreikantigen positiven Wendeschneidplatte.
PSC mit Innenkühlung.

- 1) γ = Spanwinkel (Gültig nur mit flachen Wendeschneidplatte).
- 2) λ_s = Neigungswinkel.

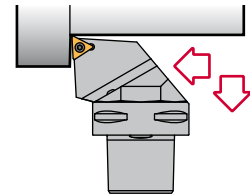

STJC 93°

Reference Bezeichnung	D5m	Dm1 min.	Dm2 min.	f1	l1	γ^1	λ_s^2	Insert size Wendeschneidplatte	Kg
PSC32-STJCR/L22040-11	32	80	124	22	40	0°	0°	TC.. 1102..	0,210
PSC40-STJCR/L27050-11	40	80	140	27	50	0°	0°	TC.. 1102..	0,420
PSC32-STJCR/L22040-16	32	110	124	22	40	0°	0°	TC.. 16T3..	0,210
PSC40-STJCR/L27050-16	40	110	140	27	50	0°	0°	TC.. 16T3..	0,420
PSC50-STJCR/L35060-16	50	110	165	35	60	0°	0°	TC.. 16T3..	0,800

Reference Bezeichnung					Nm
PSC32-STJCR/L22040-11	1225	5507	-	-	0.9
PSC40-STJCR/L27050-11	1225	5507	-	-	0.9
PSC32-STJCR/L22040-16	1335	5516	3414	1750	3.0
PSC40-STJCR/L27050-16	1335	5516	3414	1750	3.0
PSC50-STJCR/L35060-16	1335	5516	3414	1750	3.0

TC.. Triangular positive inserts with 7° clearance. A44 Dreikantige positive Wendeschneidplatten mit 7° Freiwinkel.

Reference / Bez.	l	s	d
TC.. 1102..	11,00	2,38	6,35
TC.. 16T3..	16,50	3,97	9,52

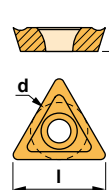

TCGT-AL



TCMT



TCMW





Characteristics:
Multipurpose profiling toolholder equipped with rhombic positive insert (angle 35°).
PSC with internal coolant.

- 1) γ = Rake angle (valid with a flat insert).
- 2) λ_s = Angle of inclination.

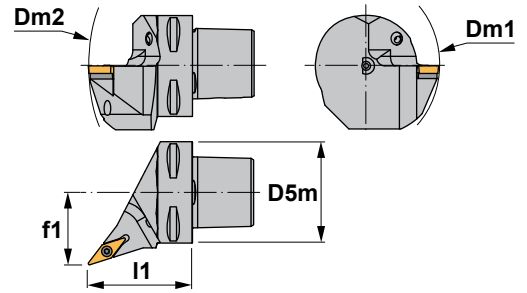

Eigenschaften:
Multifunktions-Klemmhalter zum Profildrehen mit einer rhombischen positiven Wendeschneidplatte (35° Winkel).
PSC mit Innenkühlung.

- 1) γ = Spanwinkel (Gültig nur mit flachen Wendeschneidplatte).
- 2) λ_s = Neigungswinkel.

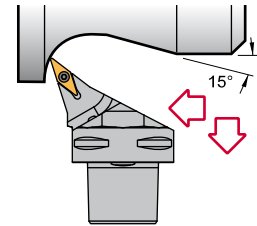

SVHB 107° 30'

Reference Bezeichnung	D5m	Dm1 min.	Dm2 min.	f1	l1	$\gamma^{(1)}$	$\lambda_{s^{(2)}}$	Insert size Wendeschneidplatte	Kg
PSC40-SVHBR/L27050-16	40	110	140	27	50	0°	0°	VBMT 1604..	0,420
PSC50-SVHBR/L35060-16	50	110	165	35	60	0°	0°	VBMT 1604..	0,800
PSC63-SVHBR/L45065-16	63	110	190	45	65	0°	0°	VBMT 1604..	1,100

Reference Bezeichnung					Nm
PSC40-SVHBR/L27050-16	1335	5516	3718	1750	3.0
PSC50-SVHBR/L35060-16	1335	5516	3718	1750	3.0
PSC63-SVHBR/L45065-16	1335	5516	3718	1750	3.0

VBMT				35° rhombic positive insert with 5° clearance. A48		35° rhombische positive Wendeschneidplatte mit 5° Freiwinkel.			
Reference / Bez.	l	s	d						
VBMT 1604..	16,50	4,76	9,52						





Characteristics:
Multipurpose profiling toolholder equipped with rhombic positive insert (angle 35°).
PSC with internal coolant.

- 1) γ = Rake angle (valid with a flat insert).
- 2) λ_s = Angle of inclination.

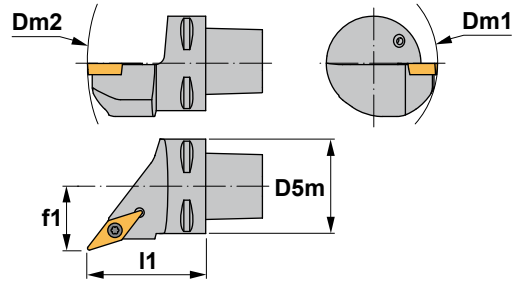

Eigenschaften:
Multifunktions-Klemmhalter zum Profildrehen mit einer rhombischen positiven Wendschneidplatte (35° Winkel).
PSC mit Innenkühlung.

- 1) γ = Spanwinkel (Gültig nur mit flachen Wendschneidplatte).
- 2) λ_s = Neigungswinkel.

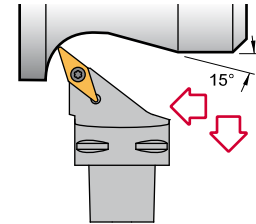

SVHC 107° 30'

Reference Bezeichnung	D5m	Dm1 min.	Dm2 min.	f1	l1	γ^1	λ_s^2	Insert size Wendschneidplatte	Kg
PSC32-SVHCR/L22040-11	32	80	124	22	40	0°	0°	VC.. 1103..	0,210
PSC40-SVHCR/L27050-11	40	80	140	27	50	0°	0°	VC.. 1103..	0,420
PSC50-SVHCR/L35060-11	50	80	165	35	60	0°	0°	VC.. 1103..	0,800
PSC40-SVHCR/L27050-16	40	110	140	27	50	0°	0°	VC.. 1604..	0,420
PSC50-SVHCR/L35060-16	50	110	165	35	60	0°	0°	VC.. 1604..	0,800
PSC63-SVHCR/L45065-16	63	110	190	45	65	0°	0°	VC.. 1604..	1,100

Reference Bezeichnung					Nm
PSC32-SVHCR/L22040-11	1225	5507	-	-	0.9
PSC40-SVHCR/L27050-11	1225	5507	-	-	0.9
PSC50-SVHCR/L35060-11	1225	5507	-	-	0.9
PSC40-SVHCR/L27050-16	1335	5516	3718	1750	3.0
PSC50-SVHCR/L35060-16	1335	5516	3718	1750	3.0
PSC63-SVHCR/L45065-16	1335	5516	3718	1750	3.0

VC.. 35° rhombic positive inserts with 7° clearance. A48
35° rhombische positive Wendschneidplatten mit 7° Freiwinkel.

Reference / Bez.	l	s	d
VC.. 1103..	11,00	3,18	6,35
VC.. 1604..	16,50	4,76	9,52

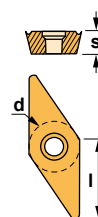

VC GT-AL



VC GT-AP



VC MT





Characteristics:
Multipurpose profiling toolholder equipped with rhombic 5° positive insert (angle 35°). PSC with internal coolant.

- 1) γ = Rake angle (valid with a flat insert).
- 2) λ_s = Angle of inclination.

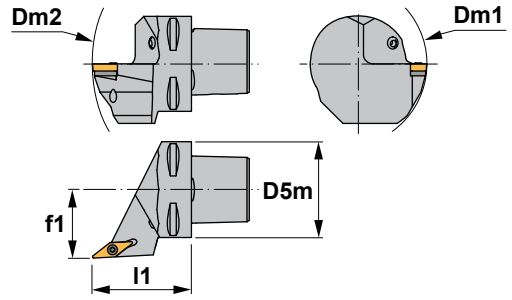

Eigenschaften:
Multifunktions-Klemmhalter zum Profildrehen mit einer 5° rhombischen positiven Wendeschneidplatte (35° Winkel). PSC mit Innenkühlung.

- 1) γ = Spanwinkel (Gültig nur mit flachen Wendeschneidplatte).
- 2) λ_s = Neigungswinkel.

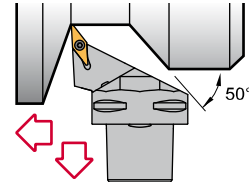

SVJB 93°

Reference Bezeichnung	D5m	Dm1 min.	Dm2 min.	f1	l1	$\gamma^{1)}$	$\lambda_{s2)}$	Insert size Wendeschneidplatte	Kg
PSC40-SVJBR/L27050-16	40	110	145	27	50	0°	0°	VBMT 1604..	0,420
PSC50-SVJBR/L35060-16	50	110	165	35	60	0°	0°	VBMT 1604..	0,800
PSC63-SVJBR/L45065-16	63	110	190	45	65	0°	0°	VBMT 1604..	1,100

Reference Bezeichnung					Nm
PSC40-SVJBR/L27050-16	1335	5516	3718	1750	3.0
PSC50-SVJBR/L35060-16	1335	5516	3718	1750	3.0
PSC63-SVJBR/L45065-16	1335	5516	3718	1750	3.0

VBMT				35° rhombic positive insert with 5° clearance. A48	
Reference / Bez.	l	s	d		
VBMT 1604..	16,50	4,76	9,52		





Characteristics:
Multipurpose profiling toolholder equipped with rhombic positive insert (angle 35°).
PSC with internal coolant.

- 1) γ = Rake angle (valid with a flat insert).
- 2) λ_s = Angle of inclination.

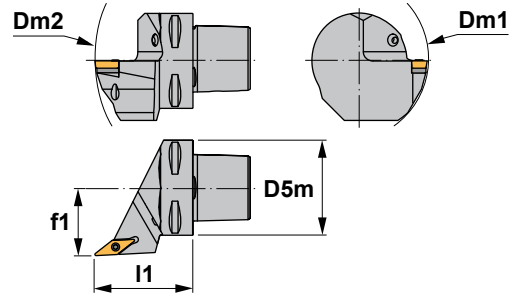

Eigenschaften:
Multifunktions-Klemmhalter zum Profildrehen mit einer rhombischen positiven Wendeschneidplatte (35° Winkel).
PSC mit Innenkühlung.

- 1) γ = Spanwinkel (Gültig nur mit flachen Wendeschneidplatte).
- 2) λ_s = Neigungswinkel.

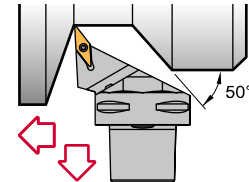

SVJC 93°

Reference Bezeichnung	D5m	Dm1 min.	Dm2 min.	f1	l1	γ^1	λ_s^2	Insert size Wendeschneidplatte	Kg
PSC32-SVJCR/L22040-11	32	80	121	22	40	0°	0°	VC.. 1103..	0,210
PSC40-SVJCR/L27050-11	40	80	145	27	50	0°	0°	VC.. 1103..	0,420
PSC50-SVJCR/L35060-11	50	80	165	35	60	0°	0°	VC.. 1103..	0,800
PSC40-SVJCR/L27050-16	40	110	145	27	50	0°	0°	VC.. 1604..	0,420
PSC50-SVJCR/L35060-16	50	110	165	35	60	0°	0°	VC.. 1604..	0,800
PSC63-SVJCR/L45065-16	63	110	190	45	65	0°	0°	VC.. 1604..	1,100

Reference Bezeichnung					Nm
PSC32-SVJCR/L22040-11	1225	5507	-	-	0.9
PSC40-SVJCR/L27050-11	1225	5507	-	-	0.9
PSC50-SVJCR/L35060-11	1225	5507	-	-	0.9
PSC40-SVJCR/L27050-16	1335	5516	3718	1750	3.0
PSC50-SVJCR/L35060-16	1335	5516	3718	1750	3.0
PSC63-SVJCR/L45065-16	1335	5516	3718	1750	3.0

VC.. 35° rhombic positive inserts with 7° clearance. A48
35° rhombische positive Wendeschneidplatten mit 7° Freiwinkel.

Reference / Bez.	l	s	d
VC.. 1103..	11,00	3,18	6,35
VC.. 1604..	16,50	4,76	9,52

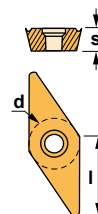

VCGT-AL



VCGT-AP



VCMT





Characteristics:

Toolholder for multi-task machining equipped with rhombic negative inserts (angle 35°).

PSC with internal coolant.

HP= High pressure coolant.

1) γ = Rake angle (valid with a flat insert).

2) λ_s = Angle of inclination.

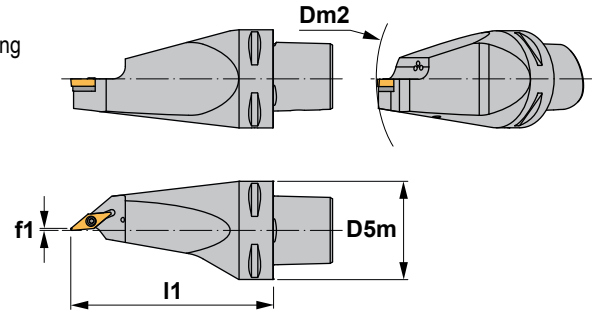

Eigenschaften:

Klemmhalter zur Multi-Task-Bearbeitung mit einer doppelseitigen rhombischen negativen Wendeschneidplatte (35° Winkel).

PSC mit Innenkühlung.

HP= Hochdruck-Kühlschmierstoff.

1) γ = Spanwinkel (Gültig nur mit flachen Wendeschneidplatte).

2) λ_s = Neigungswinkel.

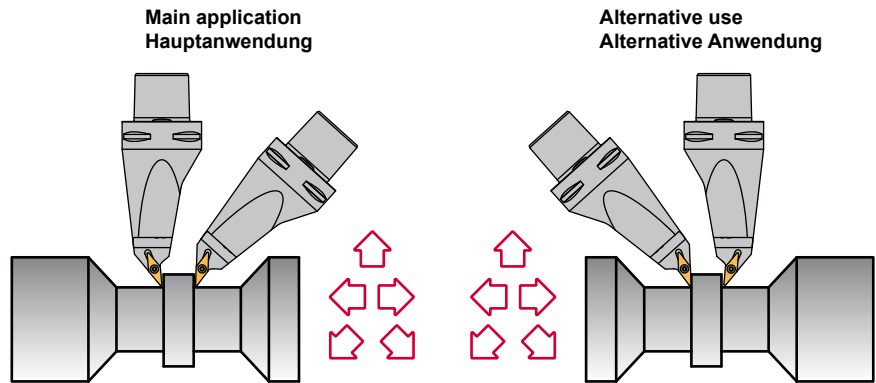

SVMB 50°

Reference Bezeichnung	D5m	Dm2 min.	f1	l1	$\gamma^1)$	$\lambda_s^2)$	Insert size Wendeschneidplatte	Kg
PSC63-SVMBR/L00130-16HP	63	110	1,2	130	0°	0°	VBMT 1604..	1,690

Reference Bezeichnung					Nm
PSC63-SVMBR/L00130-16HP	1335	5516	3718	1750	3.0

VBMT			
35° rhombic positive insert with 5° clearance. A48			
Reference / Bez.	l	s	d
VBMT 1604..	16,50	4,76	9,52

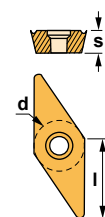

**Characteristics:**

Multipurpose profiling toolholder equipped with rhombic 5° positive insert (angle 35°). PSC with internal coolant.

- 1) γ = Rake angle (valid with a flat insert).
- 2) λ_s = Angle of inclination.

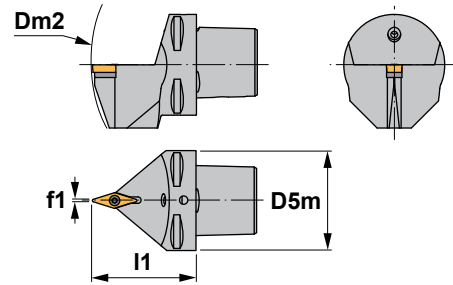
**Eigenschaften:**

Multifunktions-Klemmhalter zum Profildrehen mit einer 5° rhombischen positiven Wendeschneidplatte (35° Winkel).

PSC mit Innenkühlung.

- 1) γ = Spanwinkel (Gültig nur mit flachen Wendeschneidplatte).
- 2) λ_s = Neigungswinkel.

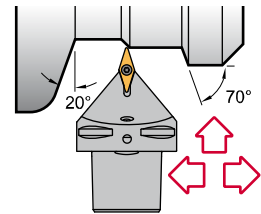

SVVB 72° 30'

Reference Bezeichnung	D5m	Dm2 min.	f1	l1	γ^1	λ_s^2	Insert size Wendeschneidplatte	kg
PSC40-SVVBN00050-16	40	140	0.6	50	0°	0°	VBMT 1604..	0,350
PSC50-SVVBN00060-16	50	165	0.6	60	0°	0°	VBMT 1604..	0,750
PSC63-SVVBN00065-16	63	190	0.6	65	0°	0°	VBMT 1604..	1,070

Reference Bezeichnung					Nm
PSC40-SVVBN00050-16	1335	5516	3718	1750	3.0
PSC50-SVVBN00060-16	1335	5516	3718	1750	3.0
PSC63-SVVBN00065-16	1335	5516	3718	1750	3.0

VBMT

35° rhombic positive insert with 5° clearance. A48
35° rhombische positive Wendeschneidplatte mit 5° Freiwinkel.

Reference / Bez.

VBMT 1604..

l

16,50

s

4,76

d

9,52

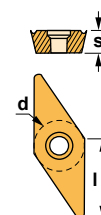
**VBMT**



Characteristics:
Multipurpose profiling toolholder equipped with rhombic positive insert (angle 35°).
PSC with internal coolant.

- 1) γ = Rake angle (valid with a flat insert).
- 2) λ_s = Angle of inclination.

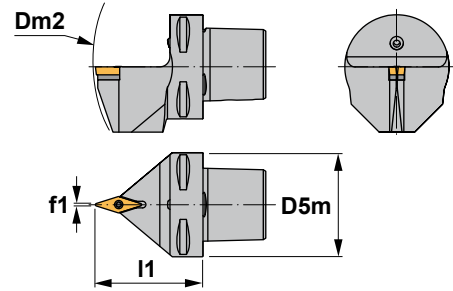

Eigenschaften:
Multifunktions-Klemmhalter zum Profildrehen mit einer rhombischen positiven Wendeschneidplatte (35° Winkel).
PSC mit Innenkühlung.

- 1) γ = Spanwinkel (Gültig nur mit flachen Wendeschneidplatte).
- 2) λ_s = Neigungswinkel.

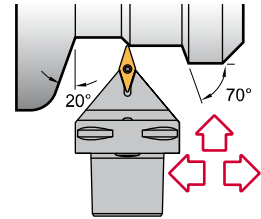

SVVC 72° 30'

Reference Bezeichnung	D5m	Dm2 min.	f1	I1	$\gamma^{1)}$	$\lambda_s^{2)}$	Insert size Wendeschneidplatte	Kg
PSC32-SVVCN00040-11	32	124	0.3	40	0°	0°	VC.. 1103..	0,160
PSC40-SVVCN00050-11	40	140	0.3	50	0°	0°	VC.. 1103..	0,350
PSC40-SVVCN00050-16	40	140	0.6	50	0°	0°	VC.. 1604..	0,350
PSC50-SVVCN00060-16	50	165	0.6	60	0°	0°	VC.. 1604..	0,750
PSC63-SVVCN00065-16	63	190	0.6	65	0°	0°	VC.. 1604..	1,070

Reference Bezeichnung					Nm
PSC32-SVVCN00040-11	1225	5507	-	-	0.9
PSC40-SVVCN00050-11	1225	5507	-	-	0.9
PSC40-SVVCN00050-16	1335	5516	3718	1750	3.0
PSC50-SVVCN00060-16	1335	5516	3718	1750	3.0
PSC63-SVVCN00065-16	1335	5516	3718	1750	3.0

VC.. 35° rhombic positive inserts with 7° clearance. A48
35° rhombische positive Wendeschneidplatten mit 7° Freiwinkel.

Reference / Bez.	l	s	d
VC.. 1103..	11,00	3,18	6,35
VC.. 1604..	16,50	4,76	9,52

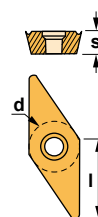

VC GT-AL



VC GT-AP



VC MT





Characteristics:
Antivibratory adaptor.

Eigenschaften:
Schwingungsgedämpfte Aufnahmen.

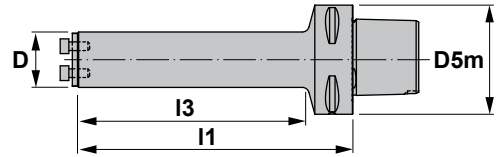

J..



Reference Bezeichnung	D5m	D	l3	l1	Kg
PSC63-J25	63	25	103	132	1,300
PSC63-J32	63	32	129	160	1,700
PSC63-J40	63	40	169	198	2,300
PSC63-J50	63	50	212	239	3,300
PSC63-J60	63	60	263	287	5,900

Reference Bezeichnung			Nm
PSC63-J25	1924	5025	2.0
PSC63-J32	1925	5003	3.0
PSC63-J40	1926	5004	3.5
PSC63-J50	1928	5005	4.0
PSC63-J60	1928	5005	4.0



Boring heads for anti-vibration bars. A238-245
Bohrköpfe für Schwingungsgedämpfte Bohrstanen.

MTUN 93°-N 	PCLN 95°-N 	PDUN 93°-N 	PWLN 95°-N
SCLC 95°-N 	SDUC 93°-N 	STFC 90°-N 	STXN 90°-N

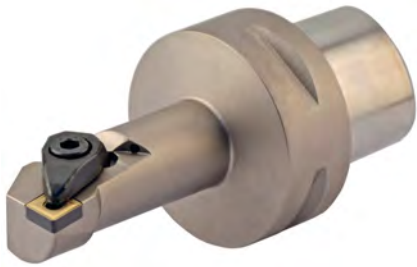

Characteristics:
Boring bar for internal turning applications equipped with rhombic negative inserts (angle 80°).
PSC with internal coolant.

- 1) γ = Rake angle (valid with a flat insert).
- 2) λ_s = Angle of inclination.

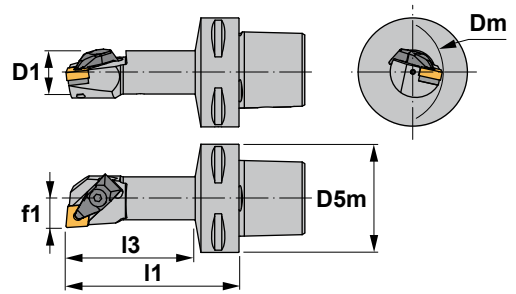

Eigenschaften:
Bohrstange zum Innendrehen mit einer rhombischen negativen Wendeschneidplatte (80° Winkel).
PSC mit Innenkühlung.

- 1) γ = Spanwinkel (Gültig nur mit flachen Wendeschneidplatte).
- 2) λ_s = Neigungswinkel.

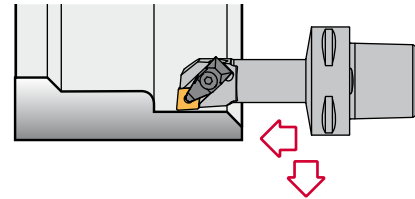

DCLN 95°

Reference Bezeichnung	Dm	D1	D5m	f1	I1	I3	γ^1	λ_{s2}	Insert size Wendeschneidplatte	
PSC40-DCLNR/L13080-09	25	20	40	13	80	57	-6°	-14°	CN.. 0903..	0,400
PSC50-DCLNR/L13080-09	25	20	50	13	80	56	-6°	-14°	CN.. 0903..	0,570
PSC40-DCLNR/L17090-12	32	25	40	17	90	68	-6°	-12°	CN.. 1204..	0,480
PSC50-DCLNR/L17090-12	32	25	50	17	90	66	-6°	-12°	CN.. 1204..	0,700
PSC63-DCLNR/L17100-12	32	25	63	17	100	72	-6°	-12°	CN.. 1204..	1,000
PSC63-DCLNR/L27140-16	50	40	63	27	140	114	-6°	-16°	CN.. 1606..	1,780

Reference Bezeichnung							Nm
PSC40-DCLNR/L13080-09	-	-	2708	1695	4294	5004	3.5
PSC50-DCLNR/L13080-09	-	-	2708	1695	4294	5004	3.5
PSC40-DCLNR/L17090-12	1766	ICSN-422	2712	1696	4295	5004	3.5
PSC50-DCLNR/L17090-12	1766	ICSN-422	2712	1696	4295	5004	3.5
PSC63-DCLNR/L17100-12	1766	ICSN-422	2712	1696	4295	5004	3.5
PSC63-DCLNR/L27140-16	1768	ICSN-533	2716	1696	4295	5004	3.5

CN..

80° rhombic negative inserts.
80° rhombische negative WSP. A32-34

Reference / Bez.	l	s	d
CN.. 0903..	9,65	3,18	9,52
CN.. 1204..	12,90	4,76	12,70
CN.. 1606..	16,10	6,35	15,88

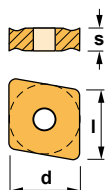



Characteristics:

Boring bar for internal turning and profiling applications equipped with rhombic negative inserts (angle 55°).
PSC with internal coolant.

- 1) γ = Rake angle (valid with a flat insert).
- 2) λ_s = Angle of inclination.

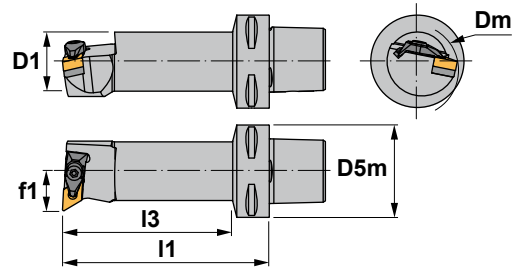

Eigenschaften:

Bohrstange zum Innen- und Profildrehen mit einer rhombischen negativen Wendeschneidplatte (55° Winkel).
PSC mit Innenkühlung.

- 1) γ = Spanwinkel (Gültig nur mit flachen Wendeschneidplatte).
- 2) λ_s = Neigungswinkel.

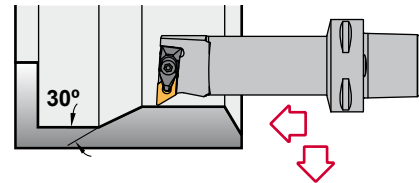

DDUN 93°

Reference Bezeichnung	Dm	D1	D5m	f1	l1	l3	γ^1	λ_{s2}	Insert size Wendeschneidplatte	kg
PSC40-DDUNR/L17090-11	32	25	40	17	90	68	-6°	-12°	DN.. 1104..	0,480
PSC50-DDUNR/L17090-11	32	25	50	17	90	66	-6°	-12°	DN.. 1104..	0,700
PSC40-DDUNR/L27080-15	50	40	40	27	80	59	-6°	-11°	DN.. 1506..	0,740
PSC50-DDUNR/L27140-15	50	40	50	27	140	118	-6°	-11°	DN.. 1506..	1,470
PSC63-DDUNR/L27140-15	50	40	63	27	140	114	-6°	-11°	DN.. 1506..	1,780

Reference Bezeichnung							Nm
PSC40-DDUNR/L17090-11	1764	IDSN-322	2708	1695	4294	5004	3.5
PSC50-DDUNR/L17090-11	1764	IDSN-322	2708	1695	4294	5004	3.5
PSC40-DDUNR/L27080-15	1766	IDSN-432	2712	1696	4295	5004	3.5
PSC50-DDUNR/L27140-15	1766	IDSN-432	2712	1696	4295	5004	3.5
PSC63-DDUNR/L27140-15	1766	IDSN-432	2712	1696	4295	5004	3.5

DN.. 55° rhombic negative inserts. A36-37
55° rhombische negative Wendeschneidplatten.

Reference / Bez.	l	s	d
DN.. 1104..	11,60	4,76	9,52
DN.. 1506..	15,50	6,35	12,70

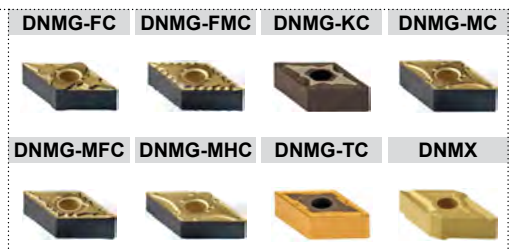
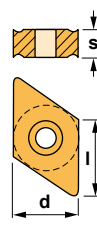



Characteristics:
Multipurpose boring bar equipped with trigon negative double-sided insert (angle 80°).
PSC with internal coolant.

- 1) γ = Rake angle (valid with a flat insert).
- 2) λ_s = Angle of inclination.

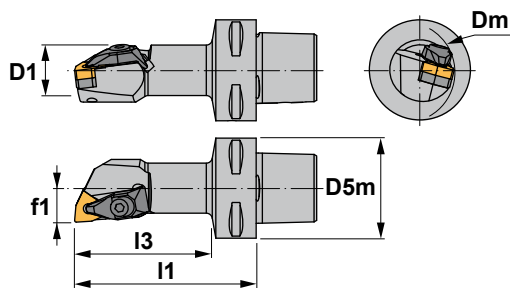

Eigenschaften:
Multifunktions-Bohrstange mit einer doppelseitigen negativen Trigon Wendschneidplatte (80° Winkel).
PSC mit Innenkühlung.

- 1) γ = Spanwinkel (Gültig nur mit flachen Wendschneidplatte).
- 2) λ_s = Neigungswinkel.

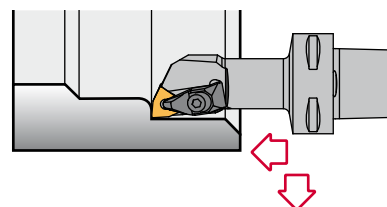

DWLN 95°

Reference Bezeichnung	Dm	D1	D5m	f1	I1	I3	γ^1	λ_s^2	Insert size Wendschneidplatte	
PSC40-DWLN/L13075-06	33	20	40	13	75	52	-6°	-17°	WNMG 0604..	0,420
PSC40-DWLN/L17090-08	35	25	40	17	90	68	-6°	-12°	WNMG 0804..	0,480
PSC50-DWLN/L17090-08	35	25	50	17	90	66	-6°	-12°	WNMG 0804..	0,700

Reference Bezeichnung							Nm
PSC40-DWLN/L13075-06	1764	IWSN-322	2708	1695	4294	5004	3.5
PSC40-DWLN/L17090-08	1766	IWSN-433	2712	1696	4295	5004	3.5
PSC50-DWLN/L17090-08	1766	IWSN-433	2712	1696	4295	5004	3.5

WNMG 80° trigon negative inserts. A50-51 80° trigon negative Wendschneidplatten.

Reference / Bez.	l	s	d
WNMG 0604..	6,45	4,76	9,52
WNMG 0804..	8,14	4,76	12,70

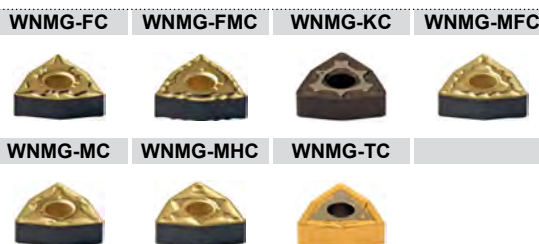
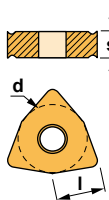



Characteristics:
Internal turning and profiling boring bar equipped with triangular negative double-sided insert.
PSC with internal coolant.

- 1) γ = Rake angle (valid with a flat insert).
- 2) λ_s = Angle of inclination.

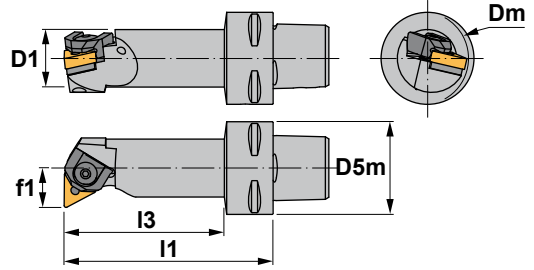

Eigenschaften:
Bohrstange zum Innen- und Profildrehen mit einer doppelseitigen dreieckigen negativen Wendeschneidplatte.
PSC mit Innenkühlung.

- 1) γ = Spanwinkel (Gültig nur mit flachen Wendeschneidplatte).
- 2) λ_s = Neigungswinkel.

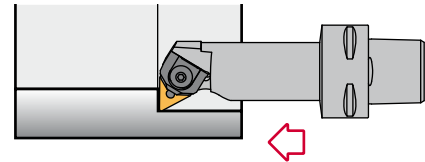

MTFN 90°

Reference Bezeichnung	Dm	D1	D5m	f1	I1	I3	γ^1	λ_{s^2}	Insert size Wendeschneidplatte	
PSC40-MTFNR/L17090-16	32	25	40	17	90	69	-6°	-13°	TNM.. 1604..	0,480
PSC40-MTFNR/L22110-16	40	32	40	22	110	89	-6°	-12°	TNM.. 1604..	0,750
PSC40-MTFNR/L27120-16	50	40	40	27	120	100	-6°	-11°	TNM.. 1604..	1,130
PSC50-MTFNR/L17090-16	32	25	50	17	90	67	-6°	-13°	TNM.. 1604..	0,700
PSC50-MTFNR/L22110-16	40	32	50	22	110	88	-6°	-12°	TNM.. 1604..	0,930
PSC50-MTFNR/L27140-16	50	40	50	27	140	119	-6°	-11°	TNM.. 1604..	1,470
PSC63-MTFNR/L22110-16	40	32	63	22	110	84	-6°	-12°	TNM.. 1604..	1,260
PSC63-MTFNR/L27140-16	50	40	63	27	140	115	-6°	-11°	TNM.. 1604..	1,780

Reference Bezeichnung						Nm
PSC40-MTFNR/L17090-16	2017	1644	5025	3414	1813	2.0
PSC40-MTFNR/L22110-16	2017	1644	5025	3414	1393	2.0
PSC40-MTFNR/L27120-16	2017	1644	5025	3414	1393	2.0
PSC50-MTFNR/L17090-16	2017	1644	5025	3414	1393	2.0
PSC50-MTFNR/L22110-16	2017	1644	5025	3414	1393	2.0
PSC50-MTFNR/L27140-16	2017	1644	5025	3414	1393	2.0
PSC63-MTFNR/L22110-16	2017	1644	5025	3414	1393	2.0
PSC63-MTFNR/L27140-16	2017	1644	5025	3414	1393	2.0

TNM..

Triangular negative inserts.
Dreieckige negative WSP. A45-46

Reference / Bez.	l	s	d
TNM.. 1604..	16,50	4,76	9,52

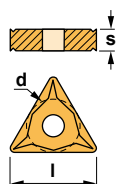



Characteristics:
Internal turning and profiling boring bar equipped with rhombic negative double-sided insert (angle 35°).
PSC with internal coolant.

- 1) γ = Rake angle (valid with a flat insert).
- 2) λ_s = Angle of inclination.

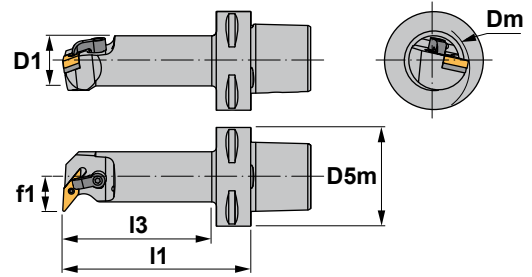

Eigenschaften:
Bohrstange zum Innen- und Profildrehen mit einer doppelseitigen rhombischen negativen Wendeschneidplatte (35° Winkel).
PSC mit Innenkühlung.

- 1) γ = Spanwinkel (Gültig nur mit flachen Wendeschneidplatte).
- 2) λ_s = Neigungswinkel.

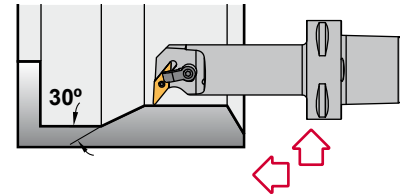

MVUN 93°

Reference Bezeichnung	Dm	D1	D5m	f1	I1	I3	γ^1	λ_s^2	Insert size Wendeschneidplatte	KG
PSC40-MVUNR/L27120-16	50	40	40	27	120	100	-6°	-10°	VN.. 1604..	1,130
PSC50-MVUNR/L27140-16	50	40	50	27	140	119	-6°	-10°	VN.. 1604..	1,470
PSC50-MVUNR/L35150-16	63	50	50	35	150	131	-6°	-10°	VN.. 1604..	2,250
PSC63-MVUNR/L22120-16	40	32	63	22	120	94	-6°	-12°	VN.. 1604..	1,280
PSC63-MVUNR/L35175-16	63	50	63	35	175	152	-6°	-10°	VN.. 1604..	2,850

Reference Bezeichnung							Nm
PSC40-MVUNR/L27120-16	2614	5003	IVSN-322	1086	1665	5002	3.0
PSC50-MVUNR/L27140-16	2614	5003	IVSN-322	1086	1665	5002	3.0
PSC50-MVUNR/L35150-16	2614	5003	IVSN-322	1086	1665	5002	3.0
PSC63-MVUNR/L22120-16	2614	5003	IVSN-322	1186	1665	5002	3.0
PSC63-MVUNR/L35175-16	2614	5003	IVSN-322	1086	1665	5002	3.0

VN.. 35° rhombic negative inserts. A49
35° rhombische negative Wendeschneidplatten.

Reference / Bez.	l	s	d
VN.. 1604..	16,50	4,76	9,52

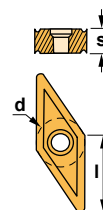

VNGP	VNMG
VNMG-TC	





Characteristics:
Multipurpose boring bar equipped with trigon negative double-sided insert (angle 80°).
PSC with internal coolant.

- 1) γ = Rake angle (valid with a flat insert).
- 2) λ_s = Angle of inclination.

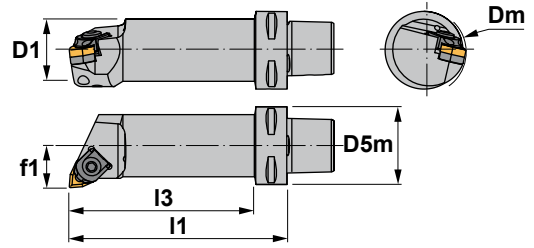

Eigenschaften:
Multifunktions-Bohrstange mit einer doppelseitigen negativen Trigon Wendeschneidplatte (80° Winkel).
PSC mit Innenkühlung.

- 1) γ = Spanwinkel (Gültig nur mit flachen Wendeschneidplatte).
- 2) λ_s = Neigungswinkel.

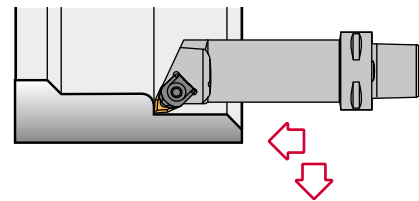

MWLN 95°

Reference Bezeichnung	Dm	D1	D5m	f1	l1	l3	γ^1	λ_s^2	Insert size Wendeschneidplatte	
PSC32-MWLN/L13075-06	25	20	32	13	75	59	-6°	-14°	WNMG 0604..	0,240
PSC32-MWLN/L17090-06	32	25	32	17	90	75	-6°	-12°	WNMG 0604..	0,360
PSC40-MWLN/L13075-06	25	20	40	13	75	53	-6°	-14°	WNMG 0604..	0,420
PSC40-MWLN/L17090-06	32	25	40	17	90	69	-6°	-12°	WNMG 0604..	0,480
PSC40-MWLN/L17090-08	32	25	40	17	90	69	-6°	-14°	WNMG 0804..	0,480
PSC40-MWLN/L22110-08	40	32	40	22	110	89	-6°	-14°	WNMG 0804..	0,750
PSC40-MWLN/L27120-08	50	40	40	27	120	100	-6°	-12°	WNMG 0804..	1,130
PSC50-MWLN/L17090-08	32	25	50	17	90	67	-6°	-14°	WNMG 0804..	0,700
PSC50-MWLN/L22110-08	40	32	50	22	110	88	-6°	-14°	WNMG 0804..	0,930
PSC50-MWLN/L27140-08	50	40	50	27	140	119	-6°	-12°	WNMG 0804..	1,470

Reference Bezeichnung						Nm
PSC32-MWLN/L13075-06	2006	5025	-	1643	1813	2.0
PSC32-MWLN/L17090-06	2006	5025	3006	1644	1813	2.0
PSC40-MWLN/L13075-06	2006	5025	-	1643	1813	2.0
PSC40-MWLN/L17090-06	2006	5025	3006	1644	1813	2.0
PSC40-MWLN/L17090-08	2011	5005	-	1647	1814	4.0
PSC40-MWLN/L22110-08	2011	5005	IWSN-433	1661	1814	4.0
PSC40-MWLN/L27120-08	2011	5005	IWSN-433	1661	1814	4.0
PSC50-MWLN/L17090-08	2011	5005	-	1647	1814	4.0
PSC50-MWLN/L22110-08	2011	5005	IWSN-433	1661	1814	4.0
PSC50-MWLN/L27140-08	2011	5005	IWSN-433	1661	1814	4.0

WNMG 80° trigon negative inserts. A50-51 80° trigon negative Wendeschneidplatten.

Reference / Bez.	l	s	d
WNMG 0604..	6,45	4,76	9,52
WNMG 0804..	8,14	4,76	12,70

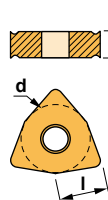



Characteristics: Boring bar for internal turning applications equipped with rhombic negative inserts (angle 80°). PSC with internal coolant.

- 1) γ = Rake angle (valid with a flat insert).
- 2) λ_s = Angle of inclination.

Eigenschaften:

Bohrstange zum Innendrehen mit einer rhombischen negativen Wendeschneidplatte (80° Winkel). PSC mit Innenkühlung.

- 1) γ = Spanwinkel (Gültig nur mit flachen Wendeschneidplatte).
- 2) λ_s = Neigungswinkel.

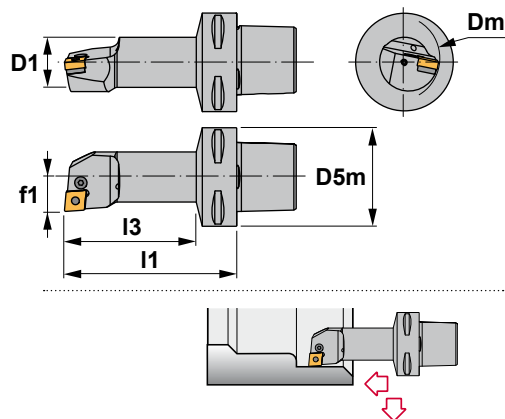

PCLN 95°

Reference Bezeichnung	Dm	D1	D5m	f1	I1	I3	$\gamma^1)$	$\lambda_s^2)$	Insert size Wendeschneidplatte	
PSC40-PCLNR/L13080-09	25	20	40	13	80	58	-6°	-11°	CN.. 0903..	0,400
PSC50-PCLNR/L13080-09	25	20	50	13	80	56	-6°	-11°	CN.. 0903..	0,570
PSC32-PCLNR/L17090-12	32	25	32	17	90	75	-6°	-11°	CN.. 1204..	0,360
PSC32-PCLNR/L22064-12	40	32	32	22	64	50	-6°	-11°	CN.. 1204..	0,350
PSC32-PCLNR/L22096-12	40	32	32	22	96	82	-6°	-11°	CN.. 1204..	0,550
PSC40-PCLNR/L17090-12	32	25	40	17	90	69	-6°	-11°	CN.. 1204..	0,480
PSC40-PCLNR/L22110-12	40	32	40	22	110	89	-6°	-11°	CN.. 1204..	0,750
PSC40-PCLNR/L27080-12	50	40	40	27	80	60	-6°	-10°	CN.. 1204..	0,740
PSC40-PCLNR/L27120-12	50	40	40	27	120	100	-6°	-11°	CN.. 1204..	1,130
PSC50-PCLNR/L17090-12	32	25	50	17	90	67	-6°	-11°	CN.. 1204..	0,700
PSC50-PCLNR/L22110-12	40	32	50	22	110	88	-6°	-11°	CN.. 1204..	0,930
PSC50-PCLNR/L27140-12	50	40	50	27	140	119	-6°	-10°	CN.. 1204..	1,470
PSC50-PCLNR/L35100-12	63	50	50	35	100	81	-6°	-7°	CN.. 1204..	1,480
PSC63-PCLNR/L17100-12	32	25	63	17	100	74	-6°	-11°	CN.. 1204..	1,000
PSC63-PCLNR/L22110-12	40	32	63	22	110	84	-6°	-11°	CN.. 1204..	1,260
PSC50-PCLNR/L35150-16	63	50	50	35	150	131	-6°	-11°	CN.. 1606..	2,250
PSC63-PCLNR/L27140-16	50	40	63	27	140	115	-6°	-11°	CN.. 1606..	1,780
PSC63-PCLNR/L35175-16	63	50	63	35	175	152	-6°	-11°	CN.. 1606..	2,850

Reference Bezeichnung							Nm
PSC40-PCLNR/L13080-09	8005	1605	5002	-	-	-	1.4
PSC50-PCLNR/L13080-09	8005	1605	5002	-	-	-	1.4
PSC32-PCLNR/L17090-12	8212	1626	5025	-	-	-	2.0
PSC32-PCLNR/L22064-12	8312	1648	5003	3612	4112	0012	3.0
PSC32-PCLNR/L22096-12	8312	1648	5003	3612	4112	0012	3.0
PSC40-PCLNR/L17090-12	8212	1626	5025	-	-	-	2.0
PSC40-PCLNR/L22110-12	8312	1648	5003	3612	4112	0012	3.0
PSC40-PCLNR/L27080-12	8012	1608	5003	3612	4112	0012	3.0
PSC40-PCLNR/L27120-12	8012	1608	5003	3612	4112	0012	3.0
PSC50-PCLNR/L17090-12	8212	1626	5025	-	-	-	2.0
PSC50-PCLNR/L22110-12	8312	1648	5003	3612	4112	0012	3.0
PSC50-PCLNR/L27140-12	8012	1608	5003	3612	4112	0012	3.0
PSC50-PCLNR/L35100-12	8012	1608	5003	3612	4112	0012	3.0
PSC63-PCLNR/L17100-12	8212	1626	5025	-	-	-	2.0
PSC63-PCLNR/L22110-12	8312	1648	5003	3612	4112	0012	3.0
PSC50-PCLNR/L35150-16	8016	1618	5003	3616	4115	0015	3.0
PSC63-PCLNR/L27140-16	8016	1618	5003	3616	4115	0015	3.0
PSC63-PCLNR/L35175-16	8016	1618	5003	3616	4115	0015	3.0

CN..

80° rhombic negative inserts.
80° rhombische negative Wendeschneidplatten. A32-34





Characteristics:

Boring bar for internal turning and profiling applications equipped with rhombic negative inserts (angle 55°). PSC with internal coolant.

- 1) γ = Rake angle (valid with a flat insert).
- 2) λ_s = Angle of inclination.

Eigenschaften:

Bohrstange zum Innen- und Profildrehen mit einer rhombischen negativen Wendschneidplatte (55° Winkel). PSC mit Innenkühlung.

- 1) γ = Spanwinkel (Gültig nur mit flachen Wendschneidplatte).
- 2) λ_s = Neigungswinkel.

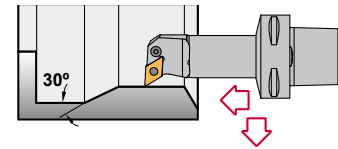
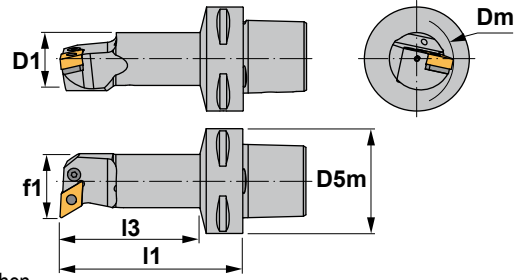

PDUN 93°

Reference Bezeichnung	Dm	D1	D5m	f1	I1	I3	γ^1	λ_s^2	Insert size Wendschneidplatte	kg
PSC32-PDUNR/L17090-11	32	25	32	17	90	75	-6°	-11°	DN.. 1104..	0,360
PSC40-PDUNR/L17090-11	32	25	40	17	90	69	-6°	-11°	DN.. 1104..	0,480
PSC40-PDUNR/L22110-11	40	32	40	22	110	89	-6°	-10°	DN.. 1104..	0,750
PSC50-PDUNR/L17090-11	32	25	50	17	90	67	-6°	-11°	DN.. 1104..	0,700
PSC50-PDUNR/L22110-11	40	32	50	22	110	88	-6°	-10°	DN.. 1104..	0,930
PSC63-PDUNR/L17100-11	32	25	63	17	100	74	-6°	-11°	DN.. 1104..	1,000
PSC40-PDUNR/L27080-15	50	40	40	27	80	60	-6°	-11°	DN.. 1506..	0,740
PSC40-PDUNR/L27120-15	50	40	40	27	120	100	-6°	-11°	DN.. 1506..	1,130
PSC50-PDUNR/L27140-15	50	40	50	27	140	119	-6°	-11°	DN.. 1506..	1,470
PSC50-PDUNR/L35100-15	63	50	50	35	100	81	-6°	-10°	DN.. 1506..	1,480
PSC50-PDUNR/L35150-15	63	50	50	35	150	131	-6°	-10°	DN.. 1506..	2,250
PSC63-PDUNR/L22110-15	40	32	63	22	110	84	-6°	-12°	DN.. 1506..	1,260
PSC63-PDUNR/L27140-15	50	40	63	27	140	115	-6°	-11°	DN.. 1506..	1,780
PSC63-PDUNR/L35175-15	63	50	63	35	175	152	-6°	-10°	DN.. 1506..	2,850

Reference Bezeichnung									Nm
PSC32-PDUNR/L17090-11	8009	1606	5025	3711	4109	0009	3725	4135	2.0
PSC40-PDUNR/L17090-11	8009	1606	5025	3711	4109	0009	3725	4135	2.0
PSC40-PDUNR/L22110-11	8009	1606	5025	3711	4109	0009	3725	4135	2.0
PSC50-PDUNR/L17090-11	8009	1606	5025	3711	4109	0009	3725	4135	2.0
PSC50-PDUNR/L22110-11	8009	1606	5025	3711	4109	0009	3725	4135	2.0
PSC63-PDUNR/L17100-11	8009	1606	5025	3711	4109	0009	3725	4135	2.0
PSC40-PDUNR/L27080-15	8415	1638	5003	3715	4112	0012	3725	4135	3.0
PSC40-PDUNR/L27120-15	8415	1638	5003	3715	4112	0012	3725	4135	3.0
PSC50-PDUNR/L27140-15	8415	1638	5003	3715	4112	0012	3725	4135	3.0
PSC50-PDUNR/L35100-15	8415	1638	5003	3715	4112	0012	3725	4135	3.0
PSC50-PDUNR/L35150-15	8415	1638	5003	3715	4112	0012	3725	4135	3.0
PSC63-PDUNR/L22110-15	8415	1638	5003	3715	4112	0012	3725	4135	3.0
PSC63-PDUNR/L27140-15	8415	1638	5003	3715	4112	0012	3725	4135	3.0
PSC63-PDUNR/L35175-15	8415	1638	5003	3715	4112	0012	3725	4135	3.0

For DNM.. 1504.. inserts
Für Wendschneidplatten DNM.. 1504..

DN..	55° rhombic negative inserts. 55° rhombische negative Wendschneidplatten. A36-37		
Reference / Bez.	l	s	d
DN.. 1104..	11,60	4,76	9,52
DN.. 1506..	15,50	6,35	12,70

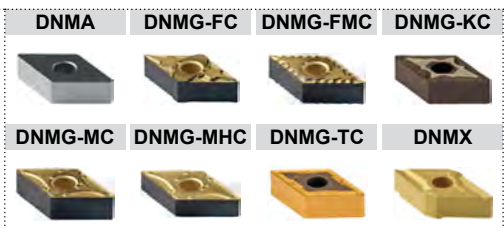
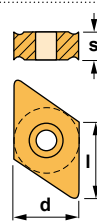



Characteristics:
Boring bar for internal turning applications equipped with square negative inserts.
PSC with internal coolant.

- 1) γ = Rake angle (valid with a flat insert).
- 2) λ_s = Angle of inclination.

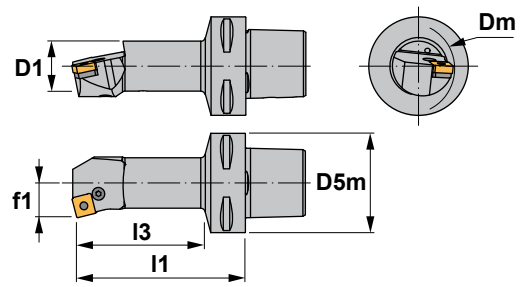

Eigenschaften:
Bohrstange zum Innendrehen mit einer vierkantigen negativen Wendeschneidplatte.
PSC mit Innenkühlung.

- 1) γ = Spanwinkel (Gültig nur mit flachen Wendeschneidplatte).
- 2) λ_s = Neigungswinkel.

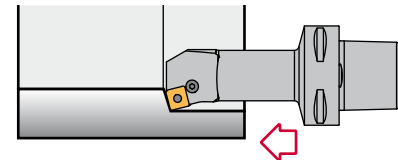

PSKN 75°

Reference Bezeichnung	Dm	D1	D5m	f1	I1	I3	γ^1	λ_s^2	Insert size Wendeschneidplatte	KG
PSC40-PSKNR/L17090-12	32	25	40	17	90	69	-6°	-11°	SNM.. 1204..	0,480
PSC50-PSKNR/L17090-12	32	25	50	17	90	67	-6°	-11°	SNM.. 1204..	0,700
PSC50-PSKNR/L22110-12	40	32	50	22	110	68	-6°	-10°	SNM.. 1204..	0,930
PSC50-PSKNR/L27140-12	50	40	50	27	140	119	-6°	-10°	SNM.. 1204..	1,470
PSC63-PSKNR/L22110-12	40	32	63	22	110	84	-6°	-10°	SNM.. 1204..	1,260

Reference Bezeichnung							Nm
PSC40-PSKNR/L17090-12	8212	1626	5025	-	-	-	2.0
PSC50-PSKNR/L17090-12	8212	1626	5025	-	-	-	2.0
PSC50-PSKNR/L22110-12	8312	1648	5003	3512	4112	0012	3.0
PSC50-PSKNR/L27140-12	8012	1608	5003	3512	4112	0012	3.0
PSC63-PSKNR/L22110-12	8012	1608	5003	3512	4112	0012	3.0

SNM.. <small>Square negative inserts. Vierkantige negative Wendeschneidplatten. A41-42</small>						
Reference / Bez.	l	s	d	SNMG-FMC	SNMG-KC	SNMG-MHC
SNM.. 1204..	12,70	4,76	12,70			
				SNMG-RC	SNMG-TC	SNMM





SCLC 95°

Characteristics:

Multipurpose boring bar equipped with rhombic positive insert (angle 80°). PSC with internal coolant.

- 1) γ = Rake angle (valid with a flat insert).
- 2) λ_s = Angle of inclination.

Eigenschaften:

Multifunktions-Bohrstange mit einer rhombischen positiven Wendeschneidplatte (80° Winkel). PSC mit Innenkühlung.

- 1) γ = Spanwinkel (Gültig nur mit flachen Wendeschneidplatte).
- 2) λ_s = Neigungswinkel.

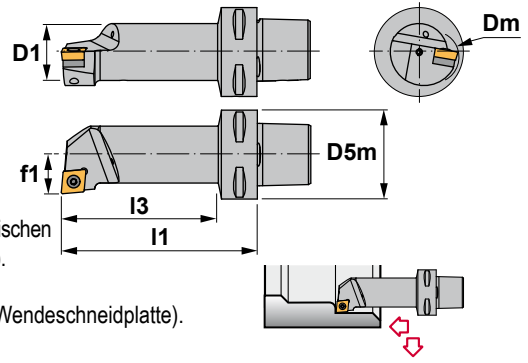

Reference Bezeichnung	Dm	D1	D5m	f1	l1	l3	γ^1	λ_s^2	Insert size Wendeschneidplatte	Kg
PSC32-SCLCR/L11065-09	20	16	32	11	65	48	0°	-12°	CC.. 09T3..	0,180
PSC32-SCLCR/L13075-09	25	20	32	13	75	59	0°	-8°	CC.. 09T3..	0,240
PSC32-SCLCR/L17090-09	32	25	32	17	90	75	0°	-6°	CC.. 09T3..	0,360
PSC40-SCLCR/L11070-09	20	16	40	11	70	47	0°	-12°	CC.. 09T3..	0,330
PSC40-SCLCR/L13080-09	25	20	40	13	80	58	0°	-8°	CC.. 09T3..	0,400
PSC40-SCLCR/L17090-09	32	25	40	17	90	69	0°	-6°	CC.. 09T3..	0,480
PSC40-SCLCR/L27080-09	50	40	40	27	80	60	0°	-6°	CC.. 09T3..	0,740
PSC50-SCLCR/L11070-09	20	16	50	11	70	46	0°	-12°	CC.. 09T3..	0,500
PSC50-SCLCR/L13080-09	25	20	50	13	80	56	0°	-8°	CC.. 09T3..	0,570
PSC50-SCLCR/L17090-09	32	25	50	17	90	67	0°	-6°	CC.. 09T3..	0,700
PSC50-SCLCR/L35100-09	63	50	50	35	100	81	0°	-4°	CC.. 09T3..	1,480
PSC32-SCLCR/L17090-12	32	25	32	17	90	75	0°	-6°	CC.. 1204..	0,360
PSC32-SCLCR/L22064-12	40	32	32	22	64	50	0°	-10°	CC.. 1204..	0,350
PSC32-SCLCR/L22096-12	40	32	32	22	96	82	0°	-10°	CC.. 1204..	0,550
PSC40-SCLCR/L17090-12	32	25	40	17	90	69	0°	-6°	CC.. 1204..	0,480
PSC40-SCLCR/L22110-12	40	32	40	22	110	89	0°	-10°	CC.. 1204..	0,750
PSC40-SCLCR/L27080-12	50	40	40	27	80	60	0°	-8°	CC.. 1204..	0,740
PSC50-SCLCR/L17090-12	32	25	50	17	90	67	0°	-6°	CC.. 1204..	0,700
PSC50-SCLCR/L22110-12	40	32	50	22	110	88	0°	-10°	CC.. 1204..	0,930
PSC50-SCLCR/L27140-12	50	40	50	27	140	119	0°	-8°	CC.. 1204..	1,470
PSC50-SCLCR/L35100-12	63	50	50	35	100	80	0°	-5°	CC.. 1204..	1,480

Reference Bezeichnung					Nm
PSC32-SCLCR/L.....-09	1440	5515	-	-	3.0
PSC40-SCLCR/L.....-09	1440	5515	-	-	3.0
PSC40-SCLCR/L17090-09	1240	5515	-	-	3.0
PSC40-SCLCR/L27080-09	1240	5515	-	-	3.0
PSC50-SCLCR/L.....-09	1440	5515	-	-	3.0
PSC50-SCLCR/L17090-09	1240	5515	-	-	3.0
PSC50-SCLCR/L35100-09	1240	5515	-	-	3.0
PSC32-SCLCR/L17090-12	1250	5515	-	-	3.0
PSC32-SCLCR/L22064-12	1540	5517	3614	1760	3.0
PSC32-SCLCR/L22096-12	1540	5517	3614	1760	3.0
PSC40-SCLCR/L17090-12	1250	5520	-	-	4.0
PSC40-SCLCR/L22110-12	1540	5517	3614	1760	3.0
PSC40-SCLCR/L27080-12	1540	5517	3614	1760	3.0
PSC50-SCLCR/L17090-12	1250	5520	-	-	4.0
PSC50-SCLCR/L22110-12	1540	5517	3614	1760	3.0
PSC50-SCLCR/L27140-12	1540	5517	3614	1760	3.0
PSC50-SCLCR/L35100-12	1540	5517	3614	1760	3.0

CC..

80° rhombic positive inserts with 7° clearance. A30-31
80° rhombische positive Wendeschneidplatten mit 7° Freiwinkel.



Characteristics:
Multipurpose profiling boring bar equipped with rhombic positive insert (angle 55°). PSC with internal coolant.
1) γ = Rake angle (valid with a flat insert).
2) λ_s = Angle of inclination.

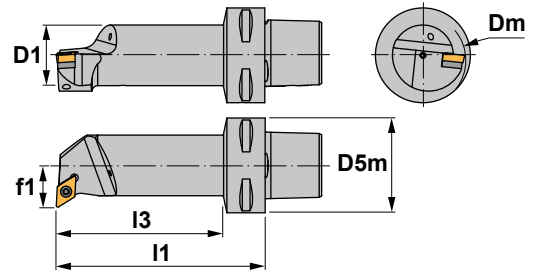

Eigenschaften:
Multifunktions-Bohrstange zum Profildrehen mit einer rhombischen positiven Wendschneidplatte (55° Winkel). PSC mit Innenkühlung.
1) γ = Spanwinkel (Gültig nur mit flachen WSP).
2) λ_s = Neigungswinkel.

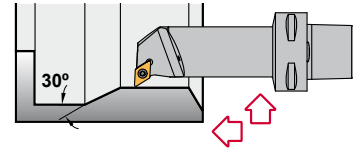

SDUC 93°

Reference Bezeichnung	Dm	D1	D5m	f1	l1	l3	$\gamma^{1)}$	$\lambda_{s2)}$	Insert size Wendschneidplatte		
PSC32-SDUCR/L11065-07	20	16	32	11	65	48	0°	-6°	DC.. 0702..	0,180	
PSC40-SDUCR/L11070-07	20	16	40	11	70	47	0°	-8°	DC.. 0702..	0,330	
PSC50-SDUCR/L11070-07	20	16	50	11	70	46	0°	-8°	DC.. 0702..	0,500	
PSC32-SDUCR/L13075-11	25	20	32	13	75	59	0°	-6°	DC.. 11T3..	0,240	
PSC32-SDUCR/L17090-11	32	25	32	17	90	75	0°	-6°	DC.. 11T3..	0,360	
PSC32-SDUCR/L22064-11	40	32	32	22	64	50	0°	-6°	DC.. 11T3..	0,350	
PSC32-SDUCR/L22096-11	40	32	32	22	96	82	0°	-6°	DC.. 11T3..	0,550	
PSC40-SDUCR/L13080-11	25	20	40	13	80	58	0°	-6°	DC.. 11T3..	0,400	
PSC40-SDUCR/L17090-11	32	25	40	17	90	69	0°	-6°	DC.. 11T3..	0,480	
PSC40-SDUCR/L22110-11	40	32	40	22	110	89	0°	-6°	DC.. 11T3..	0,750	
PSC40-SDUCR/L27080-11	50	40	40	27	80	60	0°	-6°	DC.. 11T3..	0,740	
PSC50-SDUCR/L13080-11	25	20	50	13	80	56	0°	-6°	DC.. 11T3..	0,570	
PSC50-SDUCR/L17090-11	32	25	50	17	90	67	0°	-6°	DC.. 11T3..	0,700	
PSC50-SDUCR/L22110-11	40	32	50	22	110	88	0°	-6°	DC.. 11T3..	0,930	
PSC50-SDUCR/L35100-11	63	50	50	35	100	81	0°	-4°	DC.. 11T3..	1,480	
Reference Bezeichnung											Nm
PSC32-SDUCR/L11065-07	1225				5507		-		-		0.9
PSC40-SDUCR/L11070-07	1225				5507		-		-		0.9
PSC50-SDUCR/L11070-07	1225				5507		-		-		0.9
PSC32-SDUCR/L13075-11	1240				5515		-		-		3.0
PSC32-SDUCR/L17090-11	1240				5515		-		-		3.0
PSC32-SDUCR/L22064-11	1335				5516		3714		1750		3.0
PSC32-SDUCR/L22096-11	1335				5516		3714		1750		3.0
PSC40-SDUCR/L13080-11	1240				5515		-		-		3.0
PSC40-SDUCR/L17090-11	1240				5515		-		-		3.0
PSC40-SDUCR/L22110-11	1335				5516		3714		1750		3.0
PSC40-SDUCR/L27080-11	1335				5516		3714		1750		3.0
PSC50-SDUCR/L13080-11	1240				5515		-		-		3.0
PSC50-SDUCR/L17090-11	1240				5515		-		-		3.0
PSC50-SDUCR/L22110-11	1335				5516		3714		1750		3.0
PSC50-SDUCR/L35100-11	1335				5516		3714		1750		3.0

DC.. 55° rhombic positive inserts with 7° clearance. A35
55° rhombische positive Wendschneidplatten mit 7° Freiwinkel.

Reference / Bez.	l	s	d
DC.. 0702..	7,75	2,38	6,35
DC.. 11T3..	11,60	3,97	9,52

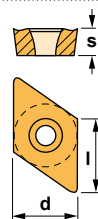

DCGT-AL



DCGT-AP



DCMT



DCMW





Characteristics:
Backwards multipurpose profiling boring bar equipped with rhombic positive insert (angle 55°). PSC with internal coolant.

- 1) γ = Rake angle (valid with a flat insert).
- 2) λ_s = Angle of inclination.

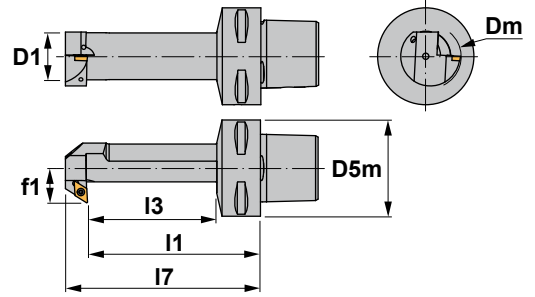

Eigenschaften:
Rückwärts-Multifunktions-Bohrstange zum Profildrehen mit einer rhombischen positiven Wendeschneidplatte (55° Winkel). PSC mit Innenkühlung.

- 1) γ = Spanwinkel (Gültig nur mit flachen Wendeschneidplatte).
- 2) λ_s = Neigungswinkel.

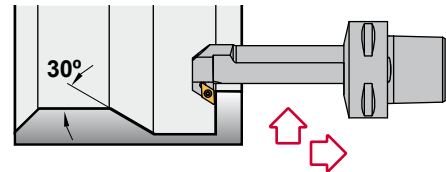

SDUC-X 93°

Reference Bezeichnung	Dm	D1	D5m	f1	I1	I3	I7	γ^1	λ_s^2	Insert size Wendeschneidplatte	KG
PSC32-SDUCR/L13070-07X	22	16	32	13	70	54	80.7	0°	-6°	DC.. 0702..	0,210
PSC32-SDUCR/L15080-07X	27	20	32	15	80	64	91.5	0°	-3°	DC.. 0702..	0,280
PSC40-SDUCR/L13070-07X	22	16	40	13	70	48	80.7	0°	-6°	DC.. 0702..	0,330
PSC40-SDUCR/L15080-07X	27	20	40	15	80	58	91.5	0°	-3°	DC.. 0702..	0,400
PSC40-SDUCR/L18090-07X	32	25	40	18	90	69	101.5	0°	-3°	DC.. 0702..	0,480
PSC50-SDUCR/L15080-07X	27	20	50	15	80	57	91.5	0°	-3°	DC.. 0702..	0,580
PSC50-SDUCR/L18090-07X	32	25	50	18	90	67	101.5	0°	-3°	DC.. 0702..	0,670

Reference Bezeichnung			Nm
PSC32-SDUCR/L13070-07X	1225	5507	0.9
PSC32-SDUCR/L15080-07X	1225	5507	0.9
PSC40-SDUCR/L13070-07X	1225	5507	0.9
PSC40-SDUCR/L15080-07X	1225	5507	0.9
PSC40-SDUCR/L18090-07X	1225	5507	0.9
PSC50-SDUCR/L15080-07X	1225	5507	0.9
PSC50-SDUCR/L18090-07X	1225	5507	0.9

DC.. 55° rhombic positive inserts with 7° clearance. A35
55° rhombische positive Wendeschneidplatten mit 7° Freiwinkel.

Reference / Bez.	l	s	d
DC.. 0702..	7,75	2,38	6,35

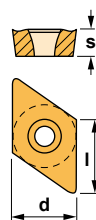

DCGT-AL **DCGT-AP**



DCMT

DCMW





Characteristics:
Multipurpose boring bar equipped with square positive insert. PSC with internal coolant.

- 1) γ = Rake angle (valid with a flat insert).
- 2) λ_s = Angle of inclination.

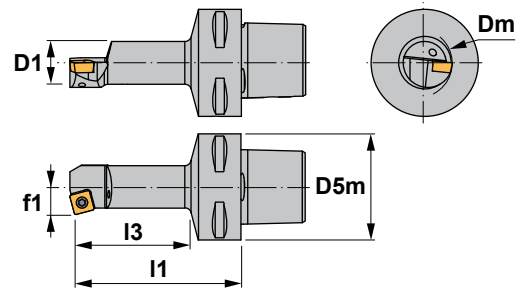

Eigenschaften:
Multifunktions-Bohrstange mit einer vierkantigen positiven Wendschneidplatte. PSC mit Innenkühlung.

- 1) γ = Spanwinkel (Gültig nur mit flachen Wendschneidplatte).
- 2) λ_s = Neigungswinkel.

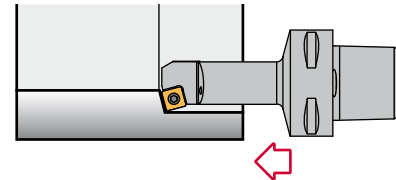

SSKC 75°

Reference Bezeichnung	Dm	D1	D5m	f1	l1	l3	γ^1	λ_{s2}	Insert size Wendschneidplatte	
PSC40-SSKCR/L13080-09	25	20	40	13	80	58	0°	-6°	SC.. 09T3..	0,400
PSC50-SSKCR/L13080-09	25	20	50	13	80	56	0°	-6°	SC.. 09T3..	0,570

Reference Bezeichnung			Nm
PSC40-SSKCR/L13080-09	1540	5517	3.0
PSC50-SSKCR/L13080-09	1540	5517	3.0

SC.. Square positive inserts with 7° clearance. A40
Vierkantige positive Wendschneidplatten mit 7° Freiwinkel.

Reference / Bez.	l	s	d
SC.. 09T3..	9,52	3,97	9,52

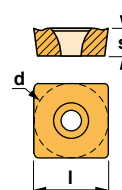

SCGT-AL



SCMT



SCMT-39





Characteristics:
Multipurpose boring bar equipped with triangular positive insert.
PSC with internal coolant.

- 1) γ = Rake angle (valid with a flat insert).
- 2) λ_s = Angle of inclination.

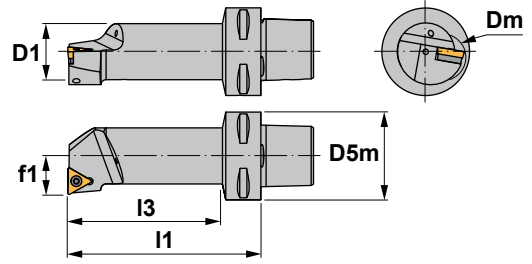

Eigenschaften:
Multifunktions-Bohrstange mit einer dreikantigen positiven Wendeschneidplatte.
PSC mit Innenkühlung.

- 1) γ = Spanwinkel (Gültig nur mit flachen Wendeschneidplatte).
- 2) λ_s = Neigungswinkel.

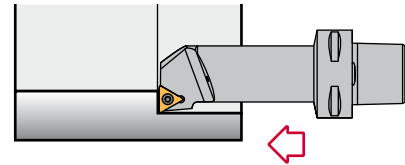

STFC 90°

Reference Bezeichnung	Dm	D1	D5m	f1	l1	l3	$\gamma^1)$	$\lambda_s^2)$	Insert size Wendeschneidplatte	
PSC32-STFCR/L11065-11	20	16	32	11	65	48	0°	-4°	TC.. 1102..	0,180
PSC32-STFCR/L13075-11	25	20	32	13	75	59	0°	-3°	TC.. 1102..	0,240
PSC40-STFCR/L11070-11	20	16	40	11	70	47	0°	-4°	TC.. 1102..	0,330
PSC40-STFCR/L13080-11	25	20	40	13	80	57	0°	-3°	TC.. 1102..	0,400
PSC50-STFCR/L11070-11	20	16	50	11	70	46	0°	-4°	TC.. 1102..	0,500
PSC50-STFCR/L13080-11	25	20	50	13	80	56	0°	-3°	TC.. 1102..	0,570
PSC32-STFCR/L17090-16	32	25	32	17	90	74	0°	-3.5°	TC.. 16T3..	0,360
PSC40-STFCR/L17090-16	32	25	40	17	90	69	0°	-6°	TC.. 16T3..	0,480
PSC40-STFCR/L22110-16	40	32	40	22	110	89	0°	-10°	TC.. 16T3..	0,750
PSC50-STFCR/L17090-16	32	25	50	17	90	67	0°	-6°	TC.. 16T3..	0,700
PSC50-STFCR/L22110-16	40	32	50	22	110	88	0°	-10°	TC.. 16T3..	0,930

Reference Bezeichnung					Nm
PSC32-STFCR/L11065-11	1225	5507	-	-	0.9
PSC32-STFCR/L13075-11	1225	5507	-	-	0.9
PSC40-STFCR/L11070-11	1225	5507	-	-	0.9
PSC40-STFCR/L13080-11	1225	5507	-	-	0.9
PSC50-STFCR/L11070-11	1225	5507	-	-	0.9
PSC50-STFCR/L13080-11	1225	5507	-	-	0.9
PSC32-STFCR/L17090-16	1240	5515	-	-	3.0
PSC40-STFCR/L17090-16	1240	5515	-	-	3.0
PSC40-STFCR/L22110-16	1335	5516	3414	1750	3.0
PSC50-STFCR/L17090-16	1240	5515	-	-	3.0
PSC50-STFCR/L22110-16	1335	5516	3414	1750	3.0

TC.. Triangular positive inserts with 7° clearance. A44 Dreikantige positive Wendeschneidplatten mit 7° Freiwinkel.

Reference / Bez.	l	s	d
TC.. 1102..	11,00	2,38	6,35
TC.. 16T3..	16,50	3,97	9,52

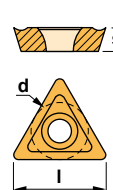

TCGT-AL



TCMT



TCMW





Characteristics:

Multipurpose profiling boring bar equipped with rhombic positive insert (angle 35°).

PSC with internal coolant.

1) γ = Rake angle (valid with a flat insert).

2) λ_s = Angle of inclination.

Eigenschaften:

Multifunktions-Bohrstange zum Profildrehen mit einer rhombischen positiven Wendeschneidplatte (35° Winkel). PSC mit Innenkühlung.

1) γ = Spanwinkel (Gültig nur mit flachen Wendeschneidplatte).

2) λ_s = Neigungswinkel.

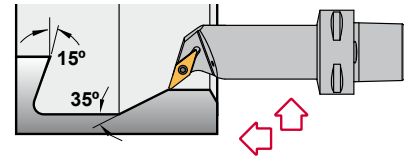
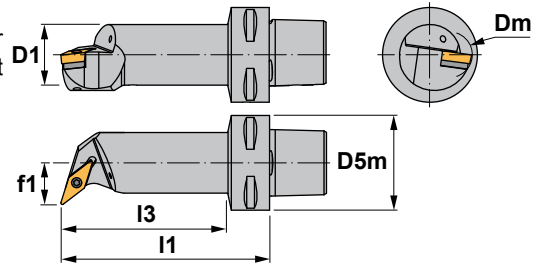

SVQB 107° 30'

Reference Bezeichnung	Dm	D1	D5m	f1	I1	I3	γ^1	λ_s^2	Insert size Wendeschneidplatte	
PSC32-SVQBR/L18090-16	33	25	32	18	90	75	0°	-6°	VBMT 1604..	0,360
PSC32-SVQBR/L22064-16	40	32	32	22	64	49	0°	-7.5°	VBMT 1604..	0,350
PSC32-SVQBR/L22096-16	40	32	32	22	96	82	0°	-8°	VBMT 1604..	0,550
PSC40-SVQBR/L18090-16	33	25	40	18	90	69	0°	-6°	VBMT 1604..	0,480
PSC40-SVQBR/L22110-16	40	32	40	22	110	89	0°	-8°	VBMT 1604..	0,750
PSC40-SVQBR/L27080-16	50	40	40	27	80	60	0°	-8°	VBMT 1604..	0,740
PSC40-SVQBR/L27120-16	50	40	40	27	120	100	0°	-8°	VBMT 1604..	1,130
PSC50-SVQBR/L18090-16	33	25	50	18	90	67	0°	-6°	VBMT 1604..	0,670
PSC50-SVQBR/L22110-16	40	32	50	22	110	88	0°	-8°	VBMT 1604..	0,930
PSC50-SVQBR/L27140-16	50	40	50	27	140	119	0°	-8°	VBMT 1604..	1,470
PSC50-SVQBR/L35100-16	63	50	50	35	100	81	0°	-7°	VBMT 1604..	1,480
PSC50-SVQBR/L35150-16	63	50	50	35	150	131	0°	-7°	VBMT 1604..	2,250
PSC63-SVQBR/L22120-16	40	32	63	22	120	94	0°	-8°	VBMT 1604..	1,280
PSC63-SVQBR/L27145-16	50	40	63	27	145	120	0°	-8°	VBMT 1604..	1,780
PSC63-SVQBR/L35175-16	63	50	63	35	175	152	0°	-8°	VBMT 1604..	2,850

Reference Bezeichnung					Nm
PSC32-SVQBR/L18090-16					3.0
PSC32-SVQBR/L22064-16					3.0
PSC32-SVQBR/L22096-16					3.0
PSC40-SVQBR/L18090-16					3.0
PSC40-SVQBR/L22110-16					3.0
PSC40-SVQBR/L27080-16					3.0
PSC40-SVQBR/L27120-16					3.0
PSC50-SVQBR/L18090-16					3.0
PSC50-SVQBR/L22110-16					3.0
PSC50-SVQBR/L27140-16					3.0
PSC50-SVQBR/L35100-16					3.0
PSC50-SVQBR/L35150-16					3.0
PSC63-SVQBR/L22120-16					3.0
PSC63-SVQBR/L27145-16					3.0
PSC63-SVQBR/L35175-16					3.0

VBMT

35° rhombic positive insert with 5° clearance. A48
35° rhombische positive Wendeschneidplatte mit 5° Freiwinkel.

Reference / Bez.	l	s	d
VBMT 1604..	16,50	4,76	9,52

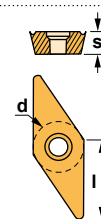

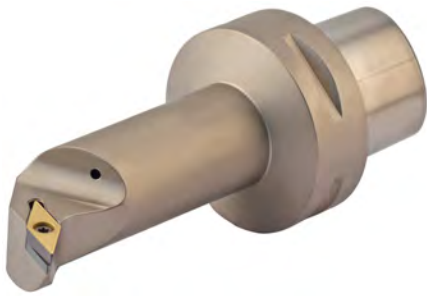

Characteristics:
Multipurpose profiling boring bar equipped with rhombic positive insert (angle 35°). PSC with internal coolant.

- 1) γ = Rake angle (valid with a flat insert).
- 2) λ_s = Angle of inclination.

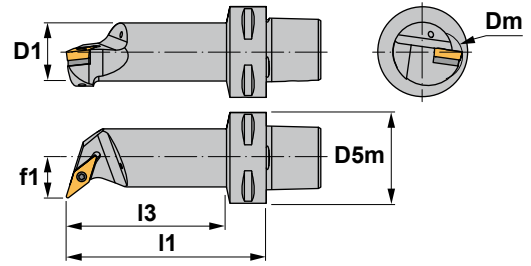

Eigenschaften:
Multifunktions-Bohrstange zum Profildrehen mit einer rhombischen positiven Wendeschneidplatte (35° Winkel). PSC mit Innenkühlung.

- 1) γ = Spanwinkel (Gültig nur mit flachen Wendeschneidplatte).
- 2) λ_s = Neigungswinkel.

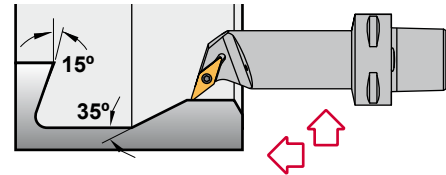

SVQC 107° 30'

Reference Bezeichnung	Dm	D1	D5m	f1	I1	I3	γ^1	λ_{s2}	Insert size Wendeschneidplatte	
PSC32-SVQCR/L13070-11	22	16	32	13	70	53.4	0°	-7°	VC.. 1103..	0,210
PSC32-SVQCR/L15080-11	27	20	32	15	80	63.9	0°	-5°	VC.. 1103..	0,280
PSC40-SVQCR/L13070-11	25	20	40	13	70	47.9	0°	-5.5°	VC.. 1103..	0,330
PSC40-SVQCR/L15080-11	27	20	40	15	80	57.9	0°	-5°	VC.. 1103..	0,400
PSC40-SVQCR/L18090-16	33	25	40	18	90	69.0	0°	-12°	VC.. 1604..	0,480
PSC40-SVQCR/L22110-16	40	32	40	22	110	89.0	0°	-8°	VC.. 1604..	0,750
PSC40-SVQCR/L27080-16	50	40	40	27	80	60.0	0°	-8°	VC.. 1604..	0,740
PSC40-SVQCR/L27120-16	50	40	40	27	120	100.0	0°	-8°	VC.. 1604..	1,130
PSC50-SVQCR/L18090-16	33	25	50	18	90	67.0	0°	-12°	VC.. 1604..	0,670
PSC50-SVQCR/L22110-16	40	32	50	22	110	88.0	0°	-8°	VC.. 1604..	0,930
PSC50-SVQCR/L27140-16	50	40	50	27	140	119.0	0°	-8°	VC.. 1604..	1,470
PSC50-SVQCR/L35100-16	63	50	50	35	100	81.0	0°	-7°	VC.. 1604..	1,480
PSC50-SVQCR/L35150-16	63	50	50	35	150	131.0	0°	-7°	VC.. 1604..	2,250
PSC63-SVQCR/L22120-16	40	32	63	22	120	94.0	0°	-8°	VC.. 1604..	1,280
PSC63-SVQCR/L27145-16	50	40	63	27	145	120.0	0°	-8°	VC.. 1604..	1,780
PSC63-SVQCR/L35175-16	63	50	63	35	175	152.0	0°	-8°	VC.. 1604..	2,850

Reference Bezeichnung					Nm
.....-11	1225	5507	-	-	0.9
.....-16	1335	5516	3718	1750	3.0

VC.. 35° rhombic positive inserts with 7° clearance. A48
35° rhombische positive Wendeschneidplatten mit 7° Freiwinkel.

Reference / Bez.	l	s	d
VC.. 1103..	11,00	3,18	6,35
VC.. 1604..	16,50	4,76	9,52

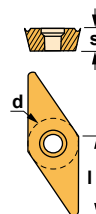

VCGT-AL VCGT-AP



VCMT





Characteristics:
Multipurpose threading toolholder
for negative lay down inserts.
PSC with internal coolant.

Eigenschaften:
Multifunktions-Klemmhalter zum
Gewindedrehen für negative
Wendeschneidplatten.
PSC mit Innenkühlung.

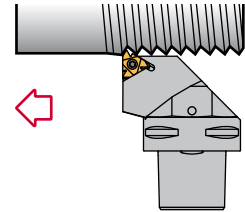
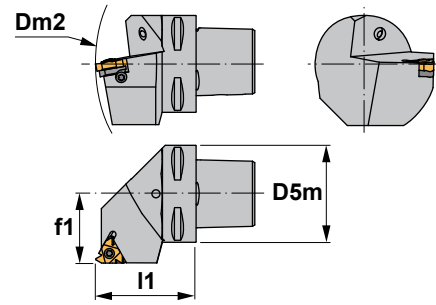

SE 90°

Reference Bezeichnung	D5m	Dm2 min.	f1	l1	Insert size Wendeschneidplatte	
PSC32-SER/L22040-16	32	124	22	40	16 ER/L..	0,210
PSC40-SER/L27050-16	40	140	27	50	16 ER/L..	0,420
PSC50-SER/L35060-16	50	165	35	60	16 ER/L..	0,800
PSC63-SER/L45065-16	63	190	45	65	16 ER/L..	1,100
PSC32-SER/L22040-22	32	124	22	40	22 ER/L..	0,210
PSC40-SER/L27050-22	40	140	27	50	22 ER/L..	0,420
PSC50-SER/L35060-22	50	165	35	60	22 ER/L..	0,800
PSC63-SER/L45065-22	63	190	45	65	22 ER/L..	1,100
PSC80-SER/L55080-22	80	250	55	80	22 ER/L..	2,740

WARNING!! Because of large thread profile, modification may have to be made to the toolholder to achieve full depth of thread.
ACHTUNG!! Bei großen Gewindeprofilen könnte eine Änderung im Klemmhalter erforderlich sein, um die volle Gewindetiefe zu erreichen.

Reference Bezeichnung			 R	 L		Nm
PSC32-SER/L22040-16	SA3	5510	YE3	YI3	SY3	2.0
PSC40-SER/L27050-16	SA3	5510	YE3	YI3	SY3	2.0
PSC50-SER/L35060-16	SA3	5510	YE3	YI3	SY3	2.0
PSC63-SER/L45065-16	SA3	5510	YE3	YI3	SY3	2.0
PSC32-SER/L22040-22	SA4	5520	YE4	YI4	SY4	4.0
PSC40-SER/L27050-22	SA4	5520	YE4	YI4	SY4	4.0
PSC50-SER/L35060-22	SA4	5520	YE4	YI4	SY4	4.0
PSC63-SER/L45065-22	SA4	5520	YE4	YI4	SY4	4.0
PSC80-SER/L55080-22	SA4	5520	YE4	YI4	SY4	4.0

E R/L

Triangular negative inserts for external threading.
Dreikantige negative Wendeschneidplatten zum Außengewindedrehen.  C03,05,08,10

Reference / Bez.	l	d
16 ER/L..	16,00	9,52
22 ER/L..	22,00	12,70

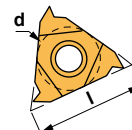

E R/L

E R/L TD



ER/L-LG







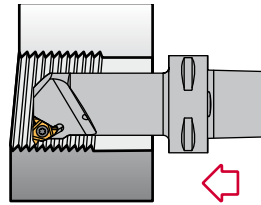
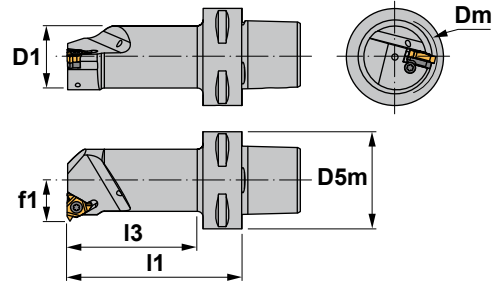

Characteristics:
Multipurpose threading boring bar for negative lay down inserts.
PSC with internal coolant.

Eigenschaften:
Multifunktions-Bohrstange zum Gewindedrehen für negative Wendeschneidplatten.
PSC mit Innenkühlung.



SI 90°

Reference Bezeichnung	D1	Dm	D5m	f1	I1	I3	Insert size Wendeschneidplatte			R	L		Nm	
PSC32-SIR/L12050-16	15.5	20	32	12	50	33	16 NR/L..	SN3	5510	-	-	-	2.0	0,210
PSC32-SIR/L14060-16	18.5	25	32	14	60	38	16 NR/L..	SA3	5510	YI3	YE3	SY3	2.0	0,340
PSC32-SIR/L22085-16	31.5	40	32	22	85	70	16 NR/L..	SA3	5510	YI3	YE3	SY3	2.0	0,510
PSC40-SIR/L12060-16	15.5	20	40	12	60	37	16 NR/L..	SN3	5510	-	-	-	2.0	0,300
PSC40-SIR/L14060-16	18.5	25	40	14	60	38	16 NR/L..	SA3T	5510	YI3	YE3	SY3	2.0	0,340
PSC40-SIR/L17070-16	24.5	32	40	17	70	48	16 NR/L..	SA3	5510	YI3	YE3	SY3	2.0	0,410
PSC40-SIR/L22090-16	32.0	40	40	22	90	69	16 NR/L..	SA3	5510	YI3	YE3	SY3	2.0	0,650
PSC40-SIR/L27080-16	39.5	50	40	27	80	60	16 NR/L..	SA3	5510	YI3	YE3	SY3	2.0	0,760
PSC50-SIR/L12060-16	15.5	20	50	12	60	35	16 NR/L..	SN3	5510	-	-	-	2.0	0,490
PSC50-SIR/L14060-16	18.5	25	50	14	60	36	16 NR/L..	SA3T	5510	YI3	YE3	SY3	2.0	0,510
PSC50-SIR/L17070-16	24.5	32	50	17	70	47	16 NR/L..	SA3	5510	YI3	YE3	SY3	2.0	0,590
PSC50-SIR/L22090-16	24.5	40	50	22	90	68	16 NR/L..	SA3	5510	YI3	YE3	SY3	2.0	0,820
PSC50-SIR/L27105-16	40.0	50	50	27	105	84	16 NR/L..	SA3	5510	YI3	YE3	SY3	2.0	1,200
PSC63-SIR/L14070-16	18.5	25	63	14	70	42	16 NR/L..	SA3T	5510	YI3	YE3	SY3	2.0	0,900
PSC63-SIR/L17075-16	24.5	32	63	17	75	48	16 NR/L..	SA3	5510	YI3	YE3	SY3	2.0	0,970
PSC63-SIR/L22090-16	32.0	40	63	22	90	64	16 NR/L..	SA3	5510	YI3	YE3	SY3	2.0	1,140
PSC63-SIR/L27105-16	40.0	50	63	27	105	80	16 NR/L..	SA3	5510	YI3	YE3	SY3	2.0	1,500
PSC40-SIR/L15065-22	18.5	25	40	15	65	42	22 NR/L..	SN4	5520	-	-	-	4.0	0,350
PSC40-SIR/L19070-22	25.0	32	40	19	70	48	22 NR/L..	SA4	5520	YI4	YE4	SY4	4.0	0,420
PSC40-SIR/L22090-22	31.5	40	40	22	90	69	22 NR/L..	SA4	5520	YI4	YE4	SY4	4.0	0,650
PSC40-SIR/L27080-22	39.5	50	40	27	80	60	22 NR/L..	SA4	5520	YI4	YE4	SY4	4.0	0,760
PSC50-SIR/L15065-22	18.5	25	50	15	65	41	22 NR/L..	SN4	5520	-	-	-	4.0	0,520
PSC50-SIR/L19070-22	25.0	32	50	19	70	47	22 NR/L..	SA4	5520	YI4	YE4	SY4	4.0	0,600
PSC50-SIR/L22090-22	31.5	40	50	22	90	68	22 NR/L..	SA4	5520	YI4	YE4	SY4	4.0	0,820
PSC50-SIR/L27105-22	40.0	50	50	27	105	84	22 NR/L..	SA4	5520	YI4	YE4	SY4	4.0	1,200
PSC63-SIR/L19075-22	25.0	32	63	19	75	48	22 NR/L..	SA4	5520	YI4	YE4	SY4	4.0	0,970
PSC63-SIR/L22090-22	31.5	40	63	22	90	64	22 NR/L..	SA4	5520	YI4	YE4	SY4	4.0	1,140
PSC63-SIR/L27105-22	40.0	50	63	27	105	80	22 NR/L..	SA4	5520	YI4	YE4	SY4	4.0	1,500

WARNING!! Because of large thread profile, modification may have to be made to the boring bar to achieve full depth of thread.
ACHTUNG!! Bei großen Gewindeprofilen könnte eine Änderung in der Bohrstange erforderlich sein, um die volle Gewindetiefe zu erreichen.

N R/L

Triangular negative inserts for internal threading.
Dreikantige negative Wendeschneidplatten zum Innengewindedrehen.  C04,06,07,09,10

Reference / Bez.

l

d

16 NR/L..

16,00

9,52

22 NR/L..

22,00

12,70

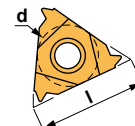

N R/L



N R/L TD





Characteristics:

Parting, grooving and side turning toolholder.
Double-sided inserts 2 to 6 mm thickness.
PSC with internal coolant.

Eigenschaften:

Klemmhalter zum Ein- und Abstechen und Längsdrehen.
Zweiseitige Wendeschneidplatten von 2 bis 6 mm Dicke.
PSC mit Innenkühlung.

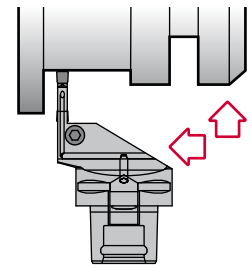
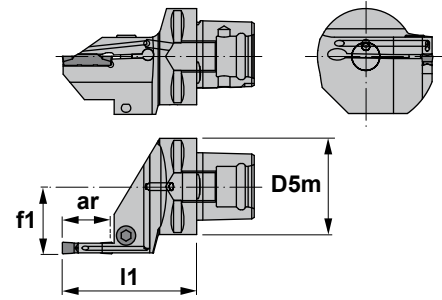

CZCD 

Reference Bezeichnung	D5m	f1	l1	ar max	Insert size Wendeschneidplatte	 	Nm	
PSC32-CZCDR/L22055-02	32	22	55	15	WDM.. 02	1296 5005	4.0	0,250
PSC40-CZCDR/L27055-02	40	27	55	15	WDM.. 02	1096 5005	4.0	0,430
PSC50-CZCDR/L35060-02	50	35	60	15	WDM.. 02	1096 5005	4.0	0,800
PSC32-CZCDR/L22055-03	32	22	55	20	WDM.. 03	1296 5005	4.0	0,250
PSC40-CZCDR/L27060-03	40	27	60	20	WDM.. 03	1096 5005	4.0	0,480
PSC50-CZCDR/L35060-03	50	35	60	20	WDM.. 03	1096 5005	4.0	0,800
PSC63-CZCDR/L45065-03	63	45	65	20	WDM.. 03	1096 5005	4.0	1,100
PSC32-CZCDR/L22060-04	32	22	60	20	WDM.. 04	1296 5005	4.0	0,260
PSC40-CZCDR/L27067-04	40	27	67	25	WDM.. 04	1096 5005	4.0	0,440
PSC50-CZCDR/L35067-04	50	35	67	25	WDM.. 04	1096 5005	4.0	0,800
PSC63-CZCDR/L45070-04	63	45	70	25	WDM.. 04	1096 5005	4.0	1,350
PSC40-CZCDR/L27067-05	40	27	67	25	WDM.. 05	1096 5005	4.0	0,440
PSC50-CZCDR/L35067-05	50	35	67	25	WDM.. 05	1096 5005	4.0	0,800
PSC63-CZCDR/L45070-05	63	45	70	25	WDM.. 05	1096 5005	4.0	1,350
PSC40-CZCDR/L27070-06	40	27	70	25	WDM.. 06	1096 5005	4.0	0,440
PSC50-CZCDR/L35070-06	50	35	70	25	WDM.. 06	1096 5005	4.0	0,780
PSC63-CZCDR/L45075-06	63	45	75	25	WDM.. 06	1096 5005	4.0	1,430

WDM..



Reference / Bez.	s
WDM.. 02	2,0
WDM.. 03	3,0
WDM.. 04	4,0
WDM.. 05	5,0
WDM.. 06	6,0

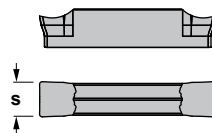

WDMG: Insert for grooving.
WDMP: Insert for parting.
WDMR: Insert for parting with radius.
WDMT: Insert for turning.
WDMG: Wendeschneidplatte zum Einstechen.
WDMP: Wendeschneidplatte zum Abstechen.
WDMR: Wendeschneidplatte zum Vollradius-Stechen.
WDMT: Wendeschneidplatte zum Drehen.

WDMG

WDMP



WDMR

WDMT



**Characteristics:**

Parting, grooving and side turning toolholder for modular blades CZFD.
Double-sided inserts 2 to 6 mm thickness.



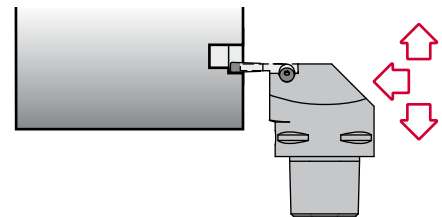
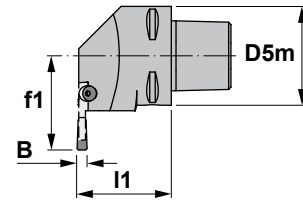
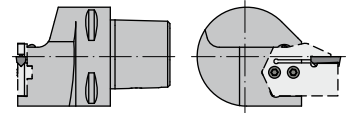

Eigenschaften:

Klemmhalter zum Ein- und Abstechen und Längsdrehen für modulare Kassetten CZFD.
Zweiseitige Wendeschneidplatten von 2 bis 6 mm Dicke.



CZFD

Reference Bezeichnung	D5m	f1	l1	B	kg
PSC32-CZFDR/L18040	32	18	40	2-6	0,250
PSC40-CZFDR/L22050	40	22	50	2-6	0,470
PSC50-CZFDR/L27060	50	27	60	2-6	0,860
PSC63-CZFDR/L34065	63	34	65	2-6	1,440

Reference Bezeichnung					Nm
PSC32-CZFDR/L18040	1025	1450	5003	5520	3.0
PSC40-CZFDR/L22050	1025	1450	5003	5520	3.0
PSC50-CZFDR/L27060	1025	1450	5003	5520	3.0
PSC63-CZFDR/L34065	1025	1450	5003	5520	3.0

For modular blades CZFD, see pages B23 to B24.
Für modulare Kassetten CZFD, siehe Seiten B23 bis B24.

Modular blades / Modulare Stechschwerter CZFD

WDM.. 02
WDM.. 03
WDM.. 04
WDM.. 05
WDM.. 06

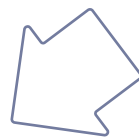

CZFD

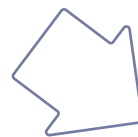

WDM.. 03
WDM.. 04
WDM.. 05
WDM.. 06



Right-handed holders use
left-handed modular blades.

Auf rechten Haltern werden linke modulare
Stechschwerter montiert.





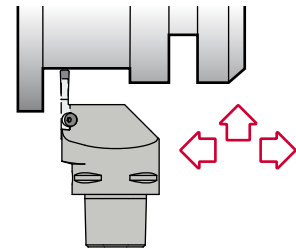
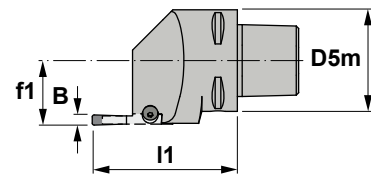
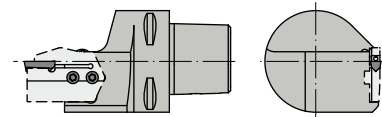

Characteristics:
Parting, grooving and side turning toolholder for modular blades CZFD.
Double-sided inserts 2 to 6 mm thickness.

Eigenschaften:
Klemmhalter zum Ein- und Abstechen und Längsdrehen für modulare Kassetten CZFD.
Zweiseitige Wendeschneidplatten von 2 bis 6 mm Dicke.



CZGD

Reference Bezeichnung	D5m	f1	I1	B	KG
PSC32-CZGDR/L22042	32	22	42	2-6	0,280
PSC40-CZGDR/L27050	40	27	50	2-6	0,490
PSC50-CZGDR/L30050	50	30	50	2-6	0,740
PSC63-CZGDR/L45055	63	45	55	2-6	1,240

Reference Bezeichnung					Nm
PSC32-CZGDR/L22042	1025	1450	5003	5520	3.0
PSC40-CZGDR/L27050	1025	1450	5003	5520	3.0
PSC50-CZGDR/L30050	1025	1450	5003	5520	3.0
PSC63-CZGDR/L45055	1025	1450	5003	5520	3.0

For modular blades CZFD, see pages B23 to B24.
Für modulare Kassetten CZFD, siehe Seiten B23 bis B24.

Modular blades / Modulare Stechschwerter CZFD





Characteristics:
 Multipurpose grooving and threading top clamp toolholder.
 Right tools require left inserts and vice versa.
 PSC with internal coolant.

Eigenschaften:
 Multifunktionaler Klemmhalter zum Einstechen und Gewindedrehen mit Top Notch Klemmung.
 Rechte Werkzeuge erfordern linke Wendeschneidplatten und umgekehrt.
 PSC mit Innenkühlung.

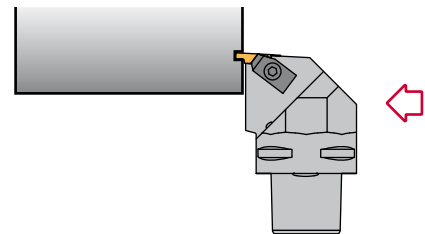
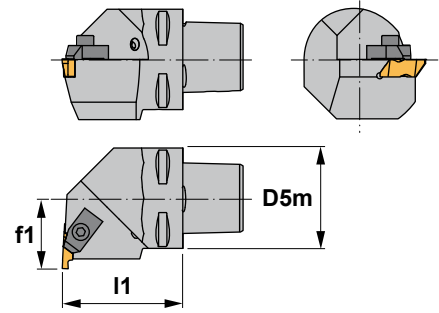

NE 93°

Reference Bezeichnung	D5m	f1	l1	Insert size Wendeschneidplatte	Kg
PSC40-NER/L27050-03	40	27	50	N.. 3	0,420
PSC50-NER/L35060-03	50	35	60	N.. 3	0,800
PSC63-NER/L45065-03	63	45	65	N.. 3	1,100

Reference Bezeichnung					Nm
PSC40-NER/L27050-03	TF-73	TF-72	5004	1495	3.5
PSC50-NER/L35060-03	TF-73	TF-72	5004	1495	3.5
PSC63-NER/L45065-03	TF-73	TF-72	5004	1495	3.5

N..

B09-10

Reference / Bez.	s
N.. 3	4,95

NG: Insert for grooving. NG: Einstechwendeschneidplatte.
 NR: Insert for parting with radius. NR: Vollradius-Stechplatte.
 NT: Insert for threading. NT: Gewindewendeschneidplatte.

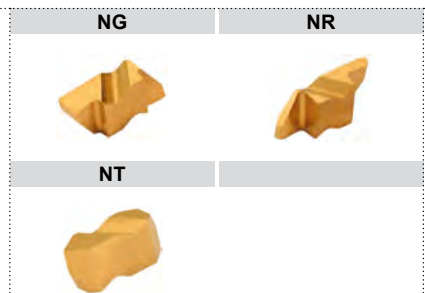
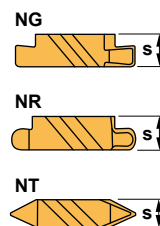



Characteristics:

Specific application grooving toolholder.
Right tools require left inserts and vice versa.

PSC with internal coolant.

Eigenschaften:

Klemmhalter zum Einstecken für spezifische Anwendungen.

Rechte Werkzeuge erfordern linke Wendeschneidplatten und umgekehrt.
PSC mit Innenkühlung.

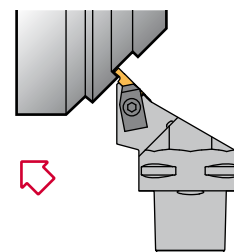
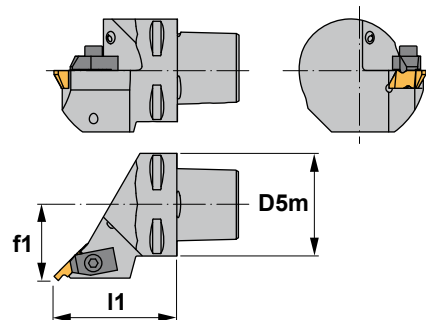

NR 45°

Reference Bezeichnung	D5m	f1	l1	Insert size Wendeschneidplatte	
PSC40-NRR/L27055-03	40	27	55	N.. 3	0,430
PSC50-NRR/L35060-03	50	35	60	N.. 3	0,800
PSC63-NRR/L45065-03	63	45	65	N.. 3	1,100

Reference Bezeichnung					Nm
PSC40-NRR/L27055-03	TF-73	TF-72	5004	1495	3.5
PSC50-NRR/L35060-03	TF-73	TF-72	5004	1495	3.5
PSC63-NRR/L45065-03	TF-73	TF-72	5004	1495	3.5

N..

B09-10

Reference / Bez.

s

N.. 3

4,95

NG: Insert for grooving.
NR: Insert for parting with radius.
NT: Insert for threading.

NG: Einstechwendeschneidplatte.
NR: Vollradius-Stechplatte.
NT: Gewindewendeschneidplatte.

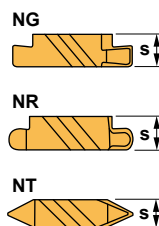

NG

NR



NT



**Characteristics:**

Multipurpose grooving and threading
top clamp toolholder.
PSC with internal coolant.

Eigenschaften:

Multifunktionaler Klemmhalter zum
Einstecken und Gewindedrehen
mit Top Notch Klemmung.
PSC mit Innenkühlung.

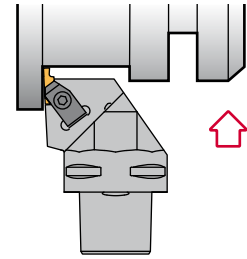
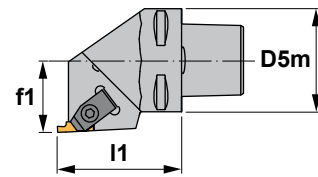
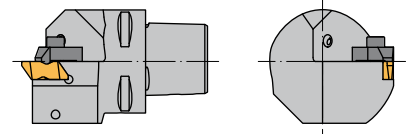
**NS 93°**

Reference Bezeichnung	D5m	f1	l1	Insert size Wendeschneidplatte	Kg
PSC32-NSR22040-02	32	22	40	N.. 2	0,210
PSC40-NSR/L27050-02	40	27	50	N.. 2	0,420
PSC32-NSR22045-03	32	22	45	N.. 3	0,240
PSC40-NSR/L27050-03	40	27	50	N.. 3	0,420
PSC50-NSR/L35060-03	50	35	60	N.. 3	0,800
PSC63-NSR/L45065-03	63	45	65	N.. 3	1,100
PSC40-NSR/L27055-04	40	27	55	N.. 4	0,430
PSC50-NSR/L35060-04	50	35	60	N.. 4	0,800
PSC63-NSR/L45065-04	63	45	65	N.. 4	1,100

Reference Bezeichnung							Nm
PSC32-NSR22040-02	TF-74	TF-75	-	-	5003	1494	3.0
PSC40-NSR/L27050-02	TF-74	TF-75	-	-	5003	1494	3.0
PSC32-NSR22045-03	TF-72	TF-73	-	-	5004	1495	3.5
PSC40-NSR/L27050-03	TF-72	TF-73	-	-	5004	1495	3.5
PSC50-NSR/L35060-03	TF-72	TF-73	-	-	5004	1495	3.5
PSC63-NSR/L45065-03	TF-72	TF-73	-	-	5004	1495	3.5
PSC40-NSR/L27055-04	TF-72	TF-73	3521	1625	5004	1495	3.5
PSC50-NSR/L35060-04	TF-72	TF-73	3521	1625	5004	1495	3.5
PSC63-NSR/L45065-04	TF-72	TF-73	3521	1625	5004	1495	3.5

N..

B09-10

Reference / Bez.

s

N.. 2	3,81
N.. 3	4,95
N.. 4	6,48

NG: Insert for grooving. NG: Einstechwendeschneidplatte.
NR: Insert for parting with radius. NR: Vollradius-Stechplatte.
NT: Insert for threading. NT: Gewindewendeschneidplatte.

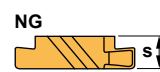

NG

NR



NT





Characteristics:
Multipurpose grooving and threading top clamp boring bar. Right tools require left inserts and vice versa. PSC with internal coolant.

Eigenschaften:
Multifunktionale Bohrstanze zum Einstechen und Gewindedrehen mit Top Notch Klemmung. Rechte Werkzeuge erfordern linke Wendeschneidplatten und umgekehrt. PSC mit Innenkühlung.

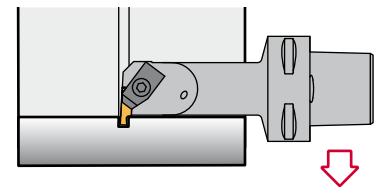
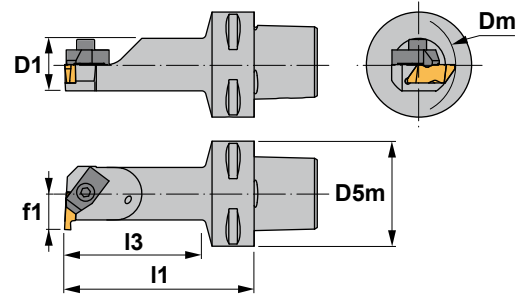

NNTO 93°

Reference Bezeichnung	Dm	D1	D5m	f1	l1	l3	Insert size Wendeschneidplatte	Kg
PSC40-NNTOR/L11070-02	22	16	40	11	70	47	N.. 2	0,330
PSC40-NNTOR/L13080-02	26	20	40	13	80	58	N.. 2	0,400
PSC50-NNTOR/L11070-02	22	16	50	11	70	46	N.. 2	0,500
PSC50-NNTOR/L13080-02	26	20	50	13	80	56	N.. 2	0,570
PSC50-NNTOR/L17090-02	34	25	50	17	90	67	N.. 2	0,700
PSC40-NNTOR/L17090-03	34	25	40	17	90	69	N.. 3	0,480
PSC50-NNTOR/L17090-03	34	25	50	17	90	67	N.. 3	0,700
PSC50-NNTOR/L22110-03	44	32	50	22	110	88	N.. 3	0,930
PSC63-NNTOR/L27140-04	54	40	63	27	140	115	N.. 4	1,780
PSC63-NNTOR/L35175-04	70	50	63	35	175	152	N.. 4	2,850

Reference Bezeichnung					Nm
PSC40-NNTOR/L11070-02	TF-147	TF-146	5003	1494	3.0
PSC40-NNTOR/L13080-02	TF-75	TF-146	5003	1494	3.0
PSC50-NNTOR/L11070-02	TF-75	TF-146	5003	1494	3.0
PSC50-NNTOR/L13080-02	TF-75	TF-146	5003	1494	3.0
PSC50-NNTOR/L17090-02	TF-75	TF-146	5003	1494	3.0
PSC40-NNTOR/L17090-03	TF-73	TF-72	5004	1495	3.5
PSC50-NNTOR/L17090-03	TF-73	TF-72	5004	1495	3.5
PSC50-NNTOR/L22110-03	TF-73	TF-72	5004	1495	3.5
PSC63-NNTOR/L27140-04	TF-73	TF-72	5004	1495	3.5
PSC63-NNTOR/L35175-04	TF-73	TF-72	5004	1495	3.5

N..

B09-10

Reference / Bez.	s
N.. 2	3,81
N.. 3	4,95
N.. 4	6,48

NG: Insert for grooving. NG: Einstechwendeschneidplatte.
NR: Insert for parting with radius. NR: Vollradius-Stechplatte.
NT: Insert for threading. NT: Gewindewendeschneidplatte.

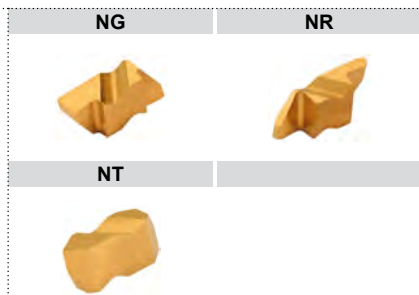
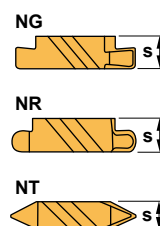

**Characteristics:**

Helical flute indexable insert drills provide faster cutting speeds and efficient chip removal for use on conventional and C.N.C. machines. This type of drills incorporates a neutral-rake geometry and screw-down square inserts for stability and clean through-hole putting. PSC with internal coolant. Max. hole depth = 3xDiameter (D)

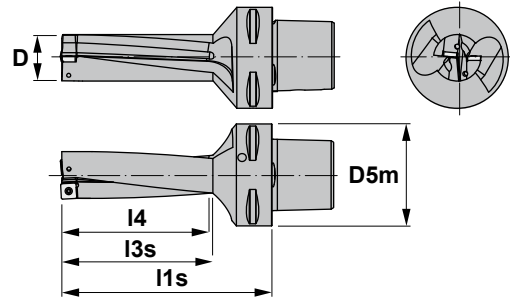
**Eigenschaften:**

Die Spiralbohrer für Wendeschneidplatten erbringen schnellere Schnittgeschwindigkeiten und eine effiziente Spanabfuhr bei konventionellen und C.N.C. Maschinen. Dieser Bohrertyp benutzt verschraubte vierkantige Wendeschneidplatten mit neutralem Spanwinkel, was Stabilität und saubere Durchgangsbohrungen erbringt. PSC mit Innenkühlung. Maximale Bohrtiefe = 3xDrm. (D)

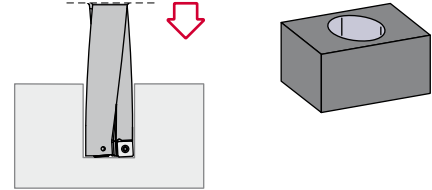
**45..**

Reference Bezeichnung	D5m	D	l1s	l3s	l4	Radial Adj. Dmax	Insert size Wendeschneidplatte		Nm	
PSC40-4514.15	40	15,0	82	48	45	+0,40↻15,8	SPMT 0603..	1225 5507	0.9	0,330
PSC40-4514.16	40	16,0	86	51	48	+0,30↻16,6	SPMT 0603..	1225 5507	0.9	0,360
PSC40-4514.17	40	17,0	89	54	51	+0,60↻18,2	SPMT 0603..	1225 5507	0.9	0,370
PSC40-4514.17,5	40	17,5	92	56	53	+0,50↻18,5	SPMT 0603..	1225 5507	0.9	0,380
PSC40-4514.18	40	18,0	93	57	54	+0,40↻18,8	SPMT 0603..	1225 5507	0.9	0,390
PSC40-4514.18,5	40	18,5	95	59	56	+0,40↻19,3	SPMT 0603..	1225 5507	0.9	0,400
PSC40-4514.19	40	19,0	96	60	57	+0,30↻19,6	SPMT 0603..	1225 5507	0.9	0,410
PSC40-4514.20	40	20,0	101	64	60	+0,90↻21,8	SPMT 0603..	1225 5507	0.9	0,440
PSC40-4524.21	40	21,0	104	66	63	+0,80↻22,6	SPMT 0703..	1225 5507	0.9	0,460
PSC40-4524.22	40	22,0	107	69	66	+0,60↻23,2	SPMT 0703..	1225 5507	0.9	0,490
PSC40-4524.23	40	23,0	111	72	69	+0,50↻24,0	SPMT 0703..	1225 5507	0.9	0,520
PSC40-4524.24	40	24,0	115	76	72	+1,10↻26,2	SPMT 0703..	1225 5507	0.9	0,560
PSC40-4524.25	40	25,0	119	79	75	+1,00↻27,0	SPMT 0703..	1225 5507	0.9	0,590
PSC40-4534.26	40	26,0	122	81	78	+0,90↻27,8	SPMT 0903..	1230 5508	1.2	0,640
PSC40-4534.27	40	27,0	125	84	81	+0,70↻28,4	SPMT 0903..	1230 5508	1.2	0,680
PSC40-4534.28	40	28,0	129	87	84	+0,60↻29,2	SPMT 0903..	1230 5508	1.2	0,720
PSC40-4534.29	40	29,0	132	90	87	+0,50↻30,0	SPMT 0903..	1230 5508	1.2	0,760
PSC40-4534.30	40	30,0	137	94	90	+1,12↻32,2	SPMT 0903..	1230 5508	1.2	0,810

SPMT

Square positive insert with 11° clearance.  H02
Vierkantige positive Wendeschneidplatte mit 11° Freiwinkel.

Reference / Bez.	l	s	d
SPMT 060304	6,35	3,18	6,35
SPMT 070308	7,94	3,18	7,94
SPMT 090308	9,52	3,18	9,52

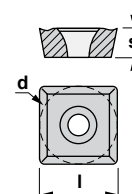
**SPMT**



Characteristics:



Helical flute indexable insert drills provide faster cutting speeds and efficient chip removal for use on conventional and C.N.C. machines.

Eigenschaften:

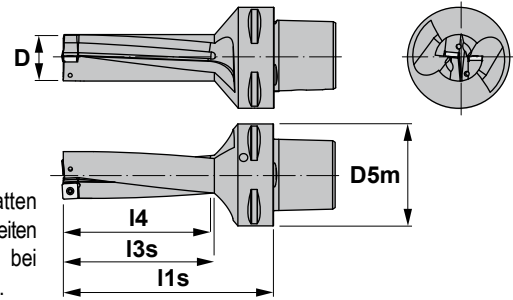
Die Spiralbohrer für Wendeschneidplatten erbringen schnellere Schnittgeschwindigkeiten und eine effiziente Spanabfuhr bei konventionellen und C.N.C. Maschinen.



45.. 

Reference Bezeichnung	D5m	D	l1s	l3s	l4	Radial Adj. Dmax	Insert size Wendeschneidplatte		Nm	
PSC50-4514.15	50	15,0	82	48	45	+0,40↔15,8	SPMT 0603..	1225 5507	0.9	0,580
PSC50-4514.16	50	16,0	86	51	48	+0,30↔16,6	SPMT 0603..	1225 5507	0.9	0,590
PSC50-4514.17	50	17,0	89	54	51	+0,60↔18,2	SPMT 0603..	1225 5507	0.9	0,600
PSC50-4514.17,5	50	17,5	92	56	53	+0,50↔18,5	SPMT 0603..	1225 5507	0.9	0,600
PSC50-4514.18	50	18,0	93	57	54	+0,40↔18,8	SPMT 0603..	1225 5507	0.9	0,600
PSC50-4514.18,5	50	18,5	95	59	56	+0,40↔19,3	SPMT 0603..	1225 5507	0.9	0,600
PSC50-4514.19	50	19,0	96	60	57	+0,30↔19,6	SPMT 0603..	1225 5507	0.9	0,610
PSC50-4514.20	50	20,0	101	64	60	+0,90↔21,8	SPMT 0603..	1225 5507	0.9	0,640
PSC50-4524.21	50	21,0	104	66	63	+0,80↔22,6	SPMT 0703..	1225 5507	0.9	0,650
PSC50-4524.22	50	22,0	107	69	66	+0,60↔23,2	SPMT 0703..	1225 5507	0.9	0,670
PSC50-4524.23	50	23,0	111	72	69	+0,50↔24,0	SPMT 0703..	1225 5507	0.9	0,700
PSC50-4524.24	50	24,0	115	76	72	+1,10↔26,2	SPMT 0703..	1225 5507	0.9	0,740
PSC50-4524.25	50	25,0	119	79	75	+1,00↔27,0	SPMT 0703..	1225 5507	0.9	0,780
PSC50-4534.26	50	26,0	122	81	78	+0,90↔27,8	SPMT 0903..	1230 5508	1.2	0,820
PSC50-4534.27	50	27,0	125	84	81	+0,70↔28,4	SPMT 0903..	1230 5508	1.2	0,820
PSC50-4534.28	50	28,0	129	87	84	+0,60↔29,2	SPMT 0903..	1230 5508	1.2	0,900
PSC50-4534.29	50	29,0	132	90	87	+0,50↔30,0	SPMT 0903..	1230 5508	1.2	0,950
PSC50-4534.30	50	30,0	137	94	90	+1,12↔32,2	SPMT 0903..	1230 5508	1.2	1,010
PSC50-4534.31	50	31,0	141	97	93	+0,99↔33,0	SPMT 0903..	1230 5508	1.2	1,060
PSC50-4534.32	50	32,0	144	100	96	+0,87↔33,7	SPMT 0903..	1230 5508	1.2	1,110
PSC50-4534.33	50	33,0	148	103	99	+0,75↔34,5	SPMT 0903..	1230 5508	1.2	1,180
PSC50-4534.34	50	34,0	151	106	102	+0,62↔35,2	SPMT 0903..	1230 5508	1.2	1,260
PSC50-4544.35	50	35,0	155	109	105	+0,50↔36,0	SPMT 1204..	1250 5520	4.0	1,330
PSC50-4544.36	50	36,0	159	112	108	+1,38↔38,8	SPMT 1204..	1250 5520	4.0	1,420
PSC50-4544.37	50	37,0	162	115	111	+1,25↔39,5	SPMT 1204..	1250 5520	4.0	1,470
PSC50-4544.38	50	38,0	166	118	114	+1,13↔40,2	SPMT 1204..	1250 5520	4.0	1,580
PSC50-4544.39	50	39,0	169	121	117	+1,00↔41,0	SPMT 1204..	1250 5520	4.0	1,640
PSC50-4544.40	50	40,0	173	124	120	+0,88↔41,8	SPMT 1204..	1250 5520	4.0	2,040
PSC50-4544.41	50	41,0	177	127	123	+0,75↔42,5	SPMT 1204..	1250 5520	4.0	2,040
PSC50-4544.42	50	42,0	186	130	126	+0,63↔43,2	SPMT 1204..	1250 5520	4.0	2,040
PSC50-4544.43	50	43,0	190	133	129	+0,50↔44,0	SPMT 1204..	1250 5520	4.0	2,150

SPMT

Square positive insert with 11° clearance.  H02
Vierkantige positive Wendeschneidplatte mit 11° Freiwinkel.

Reference / Bez.	l	s	d
SPMT 060304	6,35	3,18	6,35
SPMT 070308	7,94	3,18	7,94
SPMT 090308	9,52	3,18	9,52
SPMT 120408	12,70	4,76	12,70

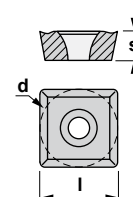

SPMT





**Characteristics:**

Helical flute indexable insert drills provide faster cutting speeds and efficient chip removal for use on conventional and C.N.C. machines.

Eigenschaften:

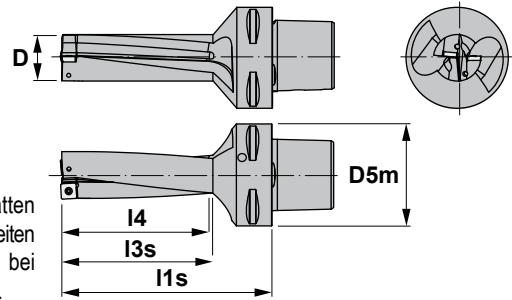
Die Spiralbohrer für Wendeschneidplatten erbringen schnellere Schnittgeschwindigkeiten und eine effiziente Spanabfuhr bei konventionellen und C.N.C. Maschinen.

**45..**

Reference Bezeichnung	D5m	D	l1s	l3s	l4	Radial Adj. Dmax	Insert size Wendeschneidplatte		Nm	
PSC63-4514.15	63	15,0	84	48	45	+0,40⇒15,8	SPMT 0603..	1225 5507	0.9	0,840
PSC63-4514.16	63	16,0	88	51	48	+0,30⇒16,6	SPMT 0603..	1225 5507	0.9	0,860
PSC63-4514.17	63	17,0	91	54	51	+0,60⇒18,2	SPMT 0603..	1225 5507	0.9	0,870
PSC63-4514.17,5	63	17,5	94	56	53	+0,50⇒18,5	SPMT 0603..	1225 5507	0.9	0,880
PSC63-4514.18	63	18,0	95	57	54	+0,40⇒18,8	SPMT 0603..	1225 5507	0.9	0,880
PSC63-4514.18,5	63	18,5	97	59	56	+0,40⇒19,3	SPMT 0603..	1225 5507	0.9	0,900
PSC63-4514.19	63	19,0	98	60	57	+0,30⇒19,6	SPMT 0603..	1225 5507	0.9	0,900
PSC63-4514.20	63	20,0	103	64	60	+0,90⇒21,8	SPMT 0603..	1225 5507	0.9	0,930
PSC63-4524.21	63	21,0	106	66	63	+0,80⇒22,6	SPMT 0703..	1225 5507	0.9	0,960
PSC63-4524.22	63	22,0	109	69	66	+0,60⇒23,2	SPMT 0703..	1225 5507	0.9	0,970
PSC63-4524.23	63	23,0	113	72	69	+0,50⇒24,0	SPMT 0703..	1225 5507	0.9	1,010
PSC63-4524.24	63	24,0	117	76	72	+1,10⇒26,2	SPMT 0703..	1225 5507	0.9	1,040
PSC63-4524.25	63	25,0	121	79	75	+1,00⇒27,0	SPMT 0703..	1225 5507	0.9	1,080
PSC63-4534.26	63	26,0	124	81	78	+0,90⇒27,8	SPMT 0903..	1230 5508	1.2	1,120
PSC63-4534.27	63	27,0	127	84	81	+0,70⇒28,4	SPMT 0903..	1230 5508	1.2	1,160
PSC63-4534.28	63	28,0	131	87	84	+0,60⇒29,2	SPMT 0903..	1230 5508	1.2	1,210
PSC63-4534.29	63	29,0	134	90	87	+0,50⇒30,0	SPMT 0903..	1230 5508	1.2	1,260
PSC63-4534.30	63	30,0	139	94	90	+1,12⇒32,2	SPMT 0903..	1230 5508	1.2	1,320
PSC63-4534.31	63	31,0	143	97	93	+0,99⇒33,0	SPMT 0903..	1230 5508	1.2	1,370
PSC63-4534.32	63	32,0	146	100	96	+0,87⇒33,7	SPMT 0903..	1230 5508	1.2	1,430
PSC63-4534.33	63	33,0	150	103	99	+0,75⇒34,5	SPMT 0903..	1230 5508	1.2	1,500
PSC63-4534.34	63	34,0	153	106	102	+0,62⇒35,2	SPMT 0903..	1230 5508	1.2	1,560
PSC63-4544.35	63	35,0	157	109	105	+0,50⇒36,0	SPMT 1204..	1250 5520	4.0	1,630
PSC63-4544.36	63	36,0	161	112	108	+1,38⇒38,8	SPMT 1204..	1250 5520	4.0	1,710
PSC63-4544.37	63	37,0	164	115	111	+1,25⇒39,5	SPMT 1204..	1250 5520	4.0	1,790
PSC63-4544.38	63	38,0	168	118	114	+1,13⇒40,2	SPMT 1204..	1250 5520	4.0	1,880
PSC63-4544.39	63	39,0	171	121	117	+1,00⇒41,0	SPMT 1204..	1250 5520	4.0	1,940
PSC63-4544.40	63	40,0	175	124	120	+0,88⇒41,8	SPMT 1204..	1250 5520	4.0	2,040
PSC63-4544.41	63	41,0	179	127	123	+0,75⇒42,5	SPMT 1204..	1250 5520	4.0	2,160
PSC63-4544.42	63	42,0	182	130	126	+0,63⇒43,2	SPMT 1204..	1250 5520	4.0	2,270
PSC63-4544.43	63	43,0	186	133	129	+0,50⇒44,0	SPMT 1204..	1250 5520	4.0	2,350

SPMT

Square positive insert with 11° clearance.  H02
Vierkantige positive Wendeschneidplatte mit 11° Freiwinkel.

Reference / Bez.	l	s	d
SPMT 060304	6,35	3,18	6,35
SPMT 070308	7,94	3,18	7,94
SPMT 090308	9,52	3,18	9,52
SPMT 120408	12,70	4,76	12,70

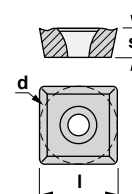
**SPMT**

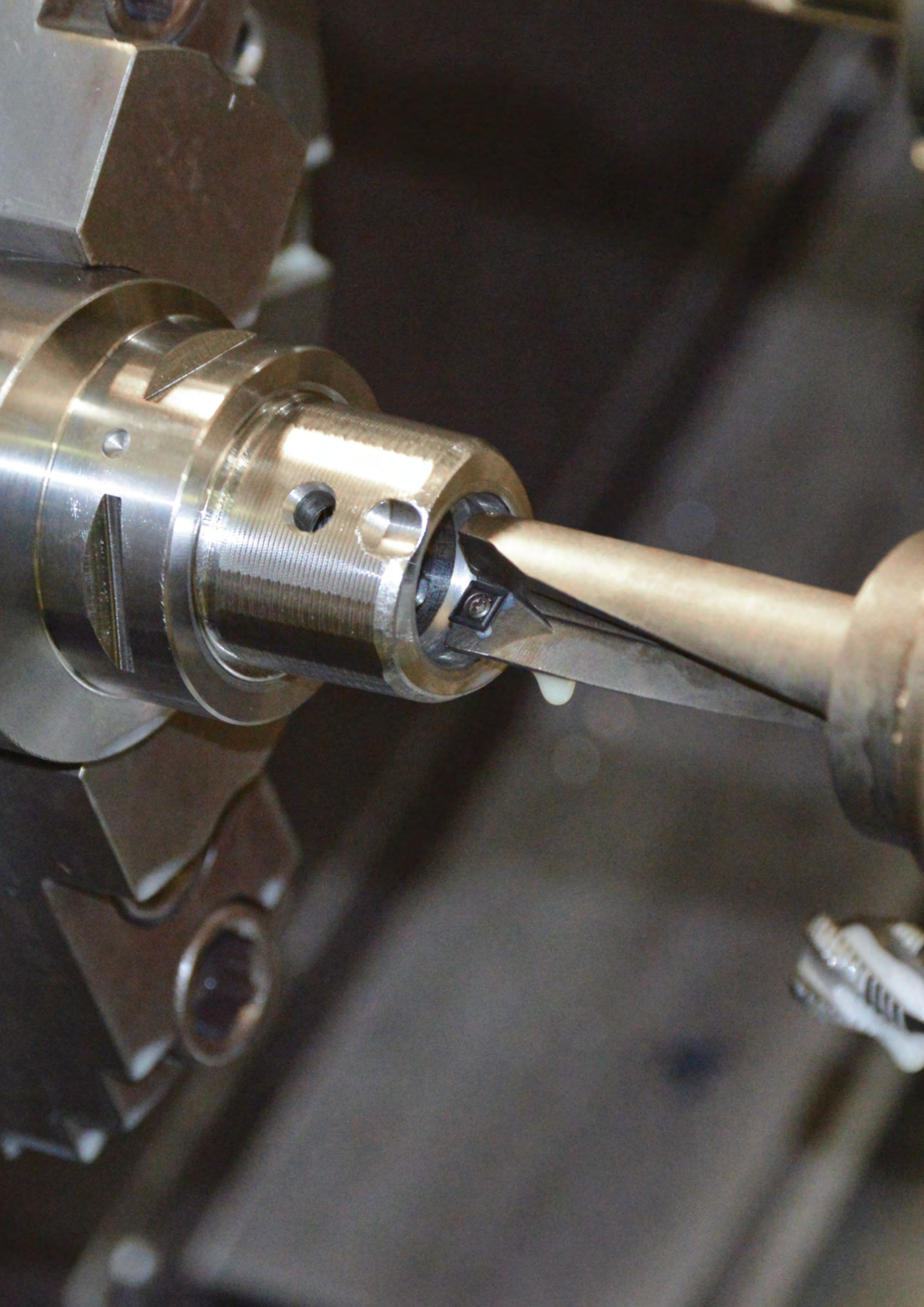

CANELA also offers a full range of adapters.

CANELA bietet auch eine breite Palette von Adaptern an.

13
ISO 7388
DIN 69871/A

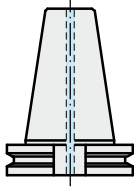

16
HSK
DIN 69893-1

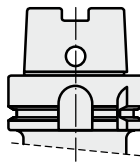

23
ISO
JIS B 6339-BT

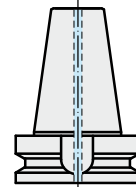

18.218
EXTENSION
VERLÄNGERUNG REDUCER
REDUZIERHÜLSE

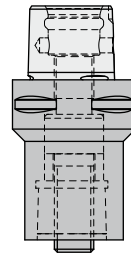
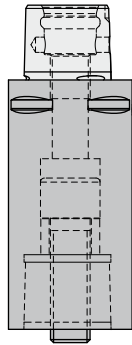

18.160 18.180 18.215 18.296 18.306 18.315 18.400 18.406 18.453 18.455

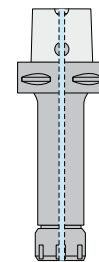
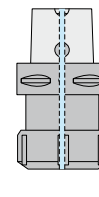
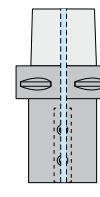
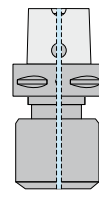
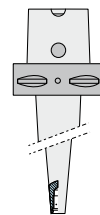
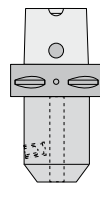
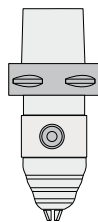
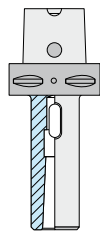
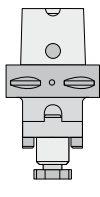
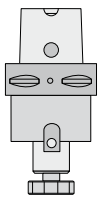

18.470 18.500 18.510 18.520 18.530 18.540 18.550 18.620 18.999

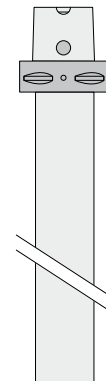
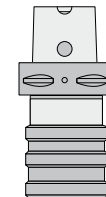
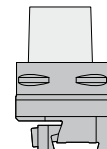
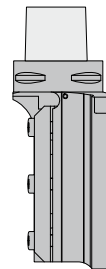
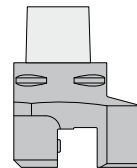
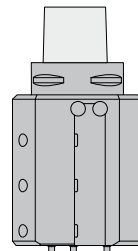
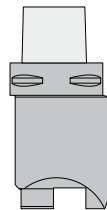
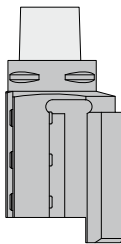
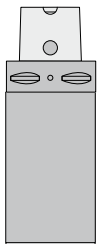

Code system / Kodifizierung

18 **160** **050** **16**

1 **2** **3** **4**



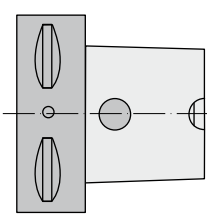

1 *Model*
Modell

PSC ISO 26623-1

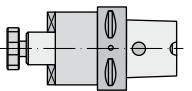
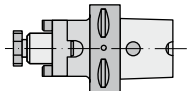
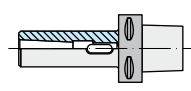
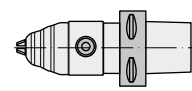
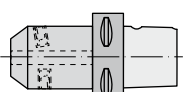
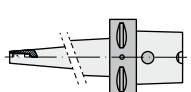
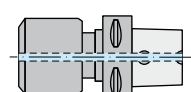
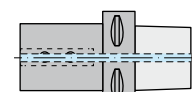
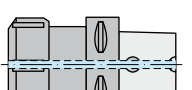
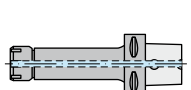

18

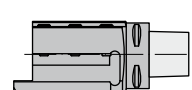
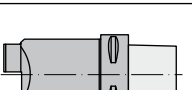
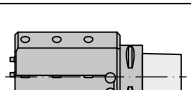
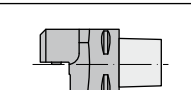
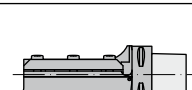
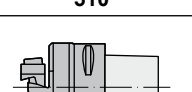
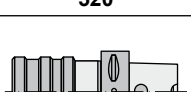
2 *Arbor type*
Aufnahmen-Typ

 160	 180	 215	 296
 306	 315	 400	 406
 453	 455	 470	 500
 510	 520	 530	 540
 550	 620	 999	



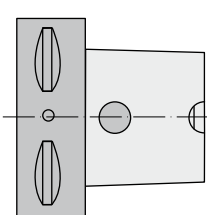

3 *Arbor size*
Aufnahmegröße

PSC ISO 26623-1

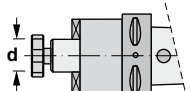
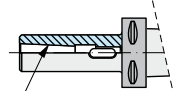
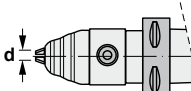
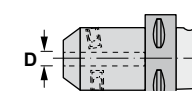
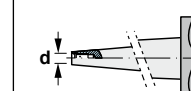
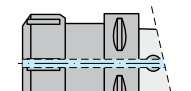

32 | 40 | 50 | 63 | 80 | 100

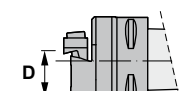
4 *Adaptor size*
Adaptergröße

 Ø 16 ... Ø 60 16 ... 60	<i>K₁ - MORSE</i>  MK2 MK3 MK4 MK5 02 03 04 05	 Ø 13 Ø 16 13 16	 Ø 25 ... Ø 100 25 ... 100	 M M M M M8 M10 M12 M16
 ER16 ... ER50 16 ... 50	 D Ø 32 ... Ø 200 32 ... 200	 D Ø 20 ... Ø 50 20 ... 50	 M3-M12 M8-M20 M14-M33 12 20 33	



AT3 TECHNICAL CHARACTERISTICS OF THE TOOLHOLDERS AT3 TECHNISCHE EIGENSCHAFTEN DER AUFNAHMEN

MATERIAL:

- Chromium-manganese carburised steel 1.7131 (16MnCr5).

EXECUTION:

- Carburised, hardened and tempered.
- Surface hardness HRC 58±2 (670±40 HV30)
- Depth of carburised layer minimum 0,5 mm.
- Tensile strength in core minimum 800 N/mm² after carburizing.

ACCURACY:

- Taper according to DIN 254
- Taper angle:
tolerance AT 3 DIN 7178 part 1 and DIN 2080 part 1.
- Other tolerances according to DIN 7160 and 7168.
- Taper surface roughness RZ<0,001 mm.

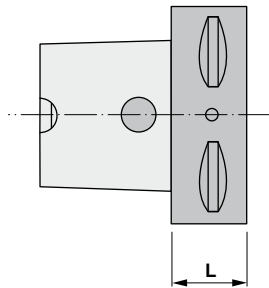

TOLERANCE AT:

- Indicates the tolerance of measuring plane D between the real and the theoretical value of the taper conicity.
- This value of measuring plane D must always be less (negative), never more (positive) in order to GUARANTEE a good toolholder fixation at the bigger taper diameter.

MATERIALIEN:

- Legierter aufgekohlter Stahl mit Chrom-Mangan 1.7131 (16MnCr5).

KONSTRUKTIONS DATEN:

- Aufgekühlt, gehärtet und angelassen.
- Oberflächenhärte HRC 58±2 (670±40 HV30)
- Aufgekühlt auf minimum 0,5 mm Tiefe.
- Zugfestigkeit im Kern minimum 800 N/mm² nach der Aufkohlung.

GENAUIGKEIT:

- Dorn nach DIN 254
- Kegelminkel:
Toleranz AT 3 DIN 7178 Teil 1 und DIN 2080 Teil 1.
- Andere Toleranzen entsprechend DIN 7160 und 7168.
- Rauigkeit der Oberfläche RZ<0,001 mm.

PSC	AT3 mm
PSC32	0,002
PSC40	0,003
PSC50	0,003
PSC63	0,004
PSC80	0,005

TOLERANZ AT:

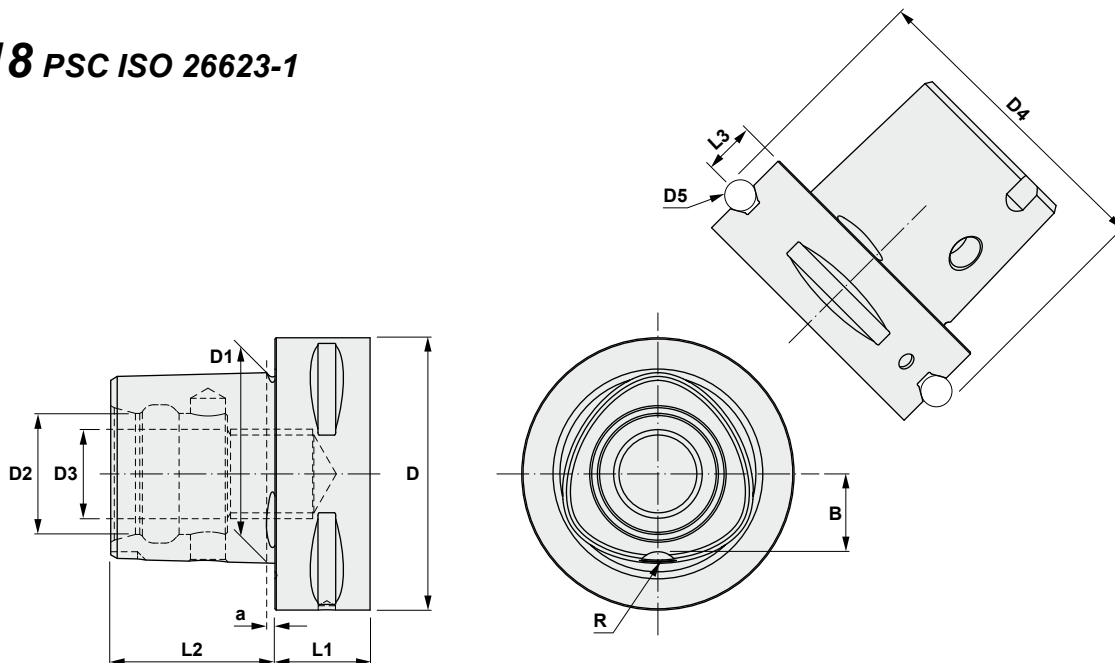

- Zeigt die Toleranz auf der Messebene D zwischen dem tatsächlichen Wert der Kegelonizität und dem theoretischen Wert.
- Dieser Wert auf der Messebene D sollte immer minus (negativ) sein, nie plus (positiv), um für einen guten Halt des Futter in den größeren Durchmesser des Kegels zu GARANTIEREN.

18 PSC ISO 26623-1



PSC	D	D1	D2	D3	D4	D5	L1 min	L2	L3	a	B	R
32	32	22	15	M12 x 1,5	39,0	5	15	19	6	2,5	9,0	3
40	40	28	18	M14 x 1,5	46,0	5	20	24	8	2,5	11,0	3
50	50	35	21	M16 x 1,5	59,3	7	20	30	10	3,0	14,0	4
63	63	44	28	M20 x 2,0	70,7	7	22	38	12	3,0	18,0	5
80	80	55	32	M20 x 2,0	86,0	7	30	48	12	3,0	22,2	6
100	100	72	43	M24 x 2,0	110,0	10	32	60	16	3,0	29,2	6

Arbors and adaptors PSC ISO 26623-1
Aufnahmen PSC ISO 26623-1

<p>18.160</p>  <p>Page / Seite E100</p>	<p>18.180</p>  <p>Page / Seite E101</p>	<p>18.215</p>  <p>Page / Seite E102</p>	<p>18.296</p>  <p>Page / Seite E103</p>	<p>18.306</p>  <p>Page / Seite E104</p>
<p>18.315</p>  <p>Page / Seite E105</p>	<p>18.400</p>  <p>Page / Seite E106</p>	<p>18.406</p>  <p>Page / Seite E107</p>	<p>18.453</p>  <p>Page / Seite E108</p>	<p>18.455</p>  <p>Page / Seite E109</p>
<p>18.470</p>  <p>Page / Seite E110</p>	<p>18.500</p>  <p>Page / Seite E111</p>	<p>18.510</p>  <p>Page / Seite E112</p>	<p>18.520</p>  <p>Page / Seite E113</p>	<p>18.530</p>  <p>Page / Seite E114</p>
<p>18.540</p>  <p>Page / Seite E115</p>	<p>18.550</p>  <p>Page / Seite E116</p>	<p>18.620</p>  <p>Page / Seite E117</p>	<p>18.999</p>  <p>Page / Seite E118</p>	
<p>13.218</p>  <p>Page / Seite E119</p>	<p>16.218</p>  <p>Page / Seite E120</p>	<p>18.218 Extension Verlängerung</p>  <p>Page / Seite E121</p>	<p>18.218 Reducer Reduzierhülse</p>  <p>Page / Seite E122</p>	<p>23.218</p>  <p>Page / Seite E123</p>
<p>18.700</p>  <p>Page / Seite E124</p>	<p>MC</p>  <p>Page / Seite E125</p>	<p>AC</p>  <p>Page / Seite E125</p>		







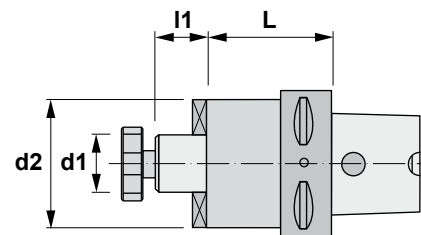

Characteristics:
Shell mill adaptor.
PSC ISO 26623-1
For cutters with driving slot DIN 138.

Eigenschaften:
Aufsteckfräsdorne.
PSC ISO 26623-1
Für Fräser mit Quernut DIN 138.



18.160

Reference Bezeichnung	PSC	d1 h6	L	l1	d2				
18.160.040.16	40	16	55	17	37	10008	86016	11103	0,560
18.160.040.22	40	22	55	19	47	10010	86022	11004	0,770
18.160.050.16	50	16	60	17	37	10008	86016	11103	0,780
18.160.050.22	50	22	60	19	47	10010	86022	11004	1,020
18.160.050.27	50	27	60	21	58	10012	86027	11005	1,270
18.160.050.32	50	32	60	24	63	10016	86032	11105	1,500
18.160.063.16	63	16	63	17	37	10008	86016	11103	1,070
18.160.063.22	63	22	25	19	47	10010	86122	11004	0,820
18.160.063.22/100	63	22	100	19	47	10010	86022	11004	1,810
18.160.063.27	63	27	25	21	58	10012	86127	11005	0,850
18.160.063.27/100	63	27	100	21	58	10012	86027	11005	2,390
18.160.063.32	63	32	25	24	63	10016	86132	11105	0,890
18.160.063.32/100	63	32	100	24	63	10016	86032	11105	2,710
18.160.063.40	63	40	40	27	89	10020	80040	11006	1,770
18.160.063.40/100	63	40	100	27	70	10020	86040	11006	3,230
18.160.080.16	80	16	50	17	37	10008	86016	11103	1,900
18.160.080.22	80	22	30	19	47	10010	86122	11004	1,760
18.160.080.22/100	80	22	100	19	47	10010	86022	11004	2,710
18.160.080.27	80	27	30	21	58	10012	86127	11005	1,790
18.160.080.27/100	80	27	100	21	58	10012	86027	11005	3,240
18.160.080.32	80	32	30	24	63	10016	86132	11105	1,830
18.160.080.32/100	80	32	100	24	63	10016	86032	11105	3,530
18.160.080.40	80	40	40	27	63	10020	86140	11006	2,380
18.160.080.40/100	80	40	100	27	70	10020	86040	11006	4,000
18.160.080.60	80	60	60	40	130	-	80060	11012	5,420
18.160.100.16	100	16	50	17	37	10008	86016	11103	3,260
18.160.100.22	100	22	50	19	47	10010	86022	11004	3,380
18.160.100.22/100	100	22	100	19	47	10010	86022	11004	4,050
18.160.100.27	100	27	50	21	58	10012	86027	11005	3,530
18.160.100.27/100	100	27	100	21	58	10012	86027	11005	4,560
18.160.100.32	100	32	50	24	63	10016	86032	11105	3,890
18.160.100.32/100	100	32	100	24	63	10016	86032	11105	5,860
18.160.100.40	100	40	50	27	63	10020	86040	11006	3,980
18.160.100.40/100	100	40	100	27	63	10020	86040	11006	5,940
18.160.100.60	100	60	70	40	130	-	80060	11012	7,610





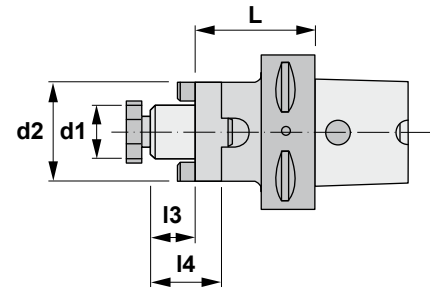

Characteristics:
Combi-Shell mill adaptor.
PSC ISO 26623-1
For cutters with keyway or driving slot
DIN 138.

Eigenschaften:
Kombi-Aufsteckfräsdorne.
PSC ISO 26623-1
Für Fräser mit Längsnut oder
Stimmitnehmer DIN 138.



18.180

Reference Bezeichnung	PSC	d1 h6	L	l3	l4	d2				
18.180.040.16	40	16	50	17	27	32	10008	60116	88016	0,450
18.180.040.22	40	22	50	19	31	40	10010	60122	88022	0,590
18.180.050.16	50	16	50	17	27	32	10008	60116	88016	0,640
18.180.050.22	50	22	50	19	31	40	10010	60122	88022	0,770
18.180.050.27	50	27	50	21	33	48	10012	60127	88027	0,930
18.180.050.32	50	32	60	24	38	58	10016	60132	88032	1,360
18.180.063.16	63	16	90	17	27	32	10008	60116	88016	1,160
18.180.063.22	63	22	90	19	31	40	10010	60122	88022	1,420
18.180.063.27	63	27	90	21	33	48	10012	60127	88027	1,740
18.180.063.32	63	32	90	24	38	58	10016	60132	88032	2,220
18.180.063.40	63	40	90	27	41	70	10020	60140	88040	2,940
18.180.080.16	80	16	100	17	27	32	10008	60116	88016	2,180
18.180.080.22	80	22	100	19	31	40	10010	60122	88022	2,450
18.180.080.27	80	27	100	21	33	48	10012	60127	88027	2,780
18.180.080.32	80	32	100	24	38	58	10016	60132	88032	3,280
18.180.080.40	80	40	100	27	41	70	10020	60140	88040	4,070
18.180.080.50	80	50	100	30	46	90	10024	60150	88050	5,550
18.180.100.16	100	16	100	17	27	32	10008	60116	88016	3,540
18.180.100.22	100	22	100	19	31	40	10010	60122	88022	3,800
18.180.100.27	100	27	100	21	33	48	10012	60127	88027	4,130
18.180.100.32	100	32	100	24	38	58	10016	60132	88032	4,610
18.180.100.40	100	40	100	27	41	70	10020	60140	88040	5,330
18.180.100.50	100	50	100	30	46	90	10024	60150	88050	6,820





Characteristics:
Reducing adaptor.
PSC ISO 26623-1
For tools with Morse taper shank
and tang DIN 228-B. Form B.

Eigenschaften:
Reduzierhülsen.
PSC ISO 26623-1
Für Werkzeuge mit Morsekegel
und Austreibblappen DIN 228-B
Form B.

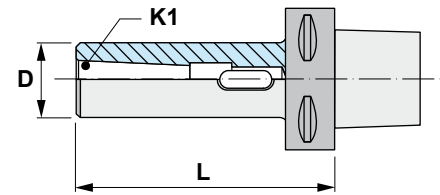

18.215

Reference Bezeichnung	PSC	K1 MORSE	L	D	 Kg
18.215.050.02	50	2	110	32	0,860
18.215.050.03	50	3	130	40	1,230
18.215.063.02	63	2	110	32	1,140
18.215.063.03	63	3	130	40	1,500
18.215.063.04	63	4	150	52	2,250
18.215.080.03	80	3	120	40	2,340
18.215.080.04	80	4	140	52	2,980
18.215.080.05	80	5	160	63	3,480
18.215.100.03	100	3	130	40	3,780
18.215.100.04	100	4	150	52	4,480
18.215.100.05	100	5	175	63	5,130





Characteristics:
CNC-Universal precision drill chucks.
PSC ISO 26623-1
For left and right hand turn.

*** SUPPLIED WITH WRENCH**

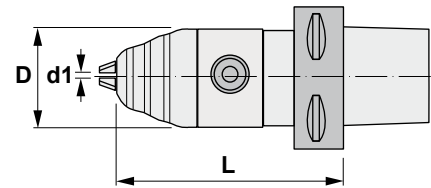

Eigenschaften:
CNC-Universal Bohrfutter,
Genauigkeitsausführung.
PSC ISO 26623-1
Für links- und rechtslaufende
Bearbeitungen.

*** LIEFERUNG MIT SCHLÜSSEL**



18.296

Reference Bezeichnung	PSC	d1	D	L	
18.296.040.13	40	0.5 - 13	50	112	1,560
18.296.050.13	50	0.5 - 13	50	112	1,730
18.296.063.13	63	0.5 - 13	50	112	2,320
18.296.063.16	63	3.0 - 16	57	112	2,350
18.296.080.13	80	0.5 - 13	50	125	3,030
18.296.080.16	80	3.0 - 16	57	125	3,280
18.296.100.13	100	0.5 - 13	50	135	4,250
18.296.100.16	100	3.0 - 16	57	135	4,400

Reference Bezeichnung		3x 
18.296.040.13	50706	60313
18.296.050.13	50706	60313
18.296.063.13	50706	60313
18.296.063.16	50706	60313
18.296.080.13	50706	60313
18.296.080.16	50706	60313
18.296.100.13	50706	60313
18.296.100.16	50706	60313

**Characteristics:**

Combined end mill adaptors type Weldon / Whistle-Notch. PSC ISO 26623-1

For tools with cylindrical shank and tightening inclined flat DIN 1835-B+E.

Eigenschaften:

Kombi-Aufnahme Typ Weldon / Whistle-Notch. PSC ISO 26623-1

Für Werkzeuge mit zylindrischem Schaft und geneigter Spannfläche DIN1835-B+E.

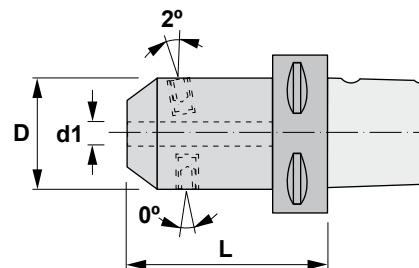

18.306

Reference Bezeichnung	PSC	d1	L	D	2x 	 kg
18.306.040.06	40	06	50	25	15106	0,350
18.306.040.08	40	08	50	28	15108	0,370
18.306.040.10	40	10	50	35	15110	0,440
18.306.040.12	40	12	55	42	15212	0,570
18.306.040.16	40	16	55	48	15314	0,650
18.306.050.06	50	06	55	25	15106	0,550
18.306.050.08	50	08	55	28	15108	0,580
18.306.050.10	50	10	65	35	15110	0,730
18.306.050.12	50	12	65	42	15212	0,870
18.306.050.14	50	14	65	42	15212	0,850
18.306.050.16	50	16	65	48	15314	0,980
18.306.050.18	50	18	65	48	15314	0,950
18.306.050.20	50	20	65	52	15216	1,020
18.306.050.25	50	25	80	65	4 x 15218	1,620
18.306.063.06	63	06	80	25	15106	0,920
18.306.063.08	63	08	80	28	15108	0,960
18.306.063.10	63	10	80	35	15110	1,100
18.306.063.12	63	12	80	42	15212	1,280
18.306.063.14	63	14	80	42	15212	1,260
18.306.063.16	63	16	80	48	15314	1,430
18.306.063.18	63	18	80	48	15314	1,400
18.306.063.20	63	20	80	52	15216	1,510
18.306.063.25	63	25	90	65	4 x 15218	2,080
18.306.063.32	63	32	90	72	4 x 15220	1,890
18.306.063.40	63	40	95	80	4 x 15220	1,680
18.306.080.06	80	06	80	25	15106	1,900
18.306.080.08	80	08	80	28	15108	1,940
18.306.080.10	80	10	80	35	15110	2,060
18.306.080.12	80	12	80	42	15212	2,210
18.306.080.14	80	14	80	42	15212	2,190
18.306.080.16	80	16	80	48	15314	2,330
18.306.080.20	80	20	80	52	15216	2,400
18.306.080.25	80	25	90	65	4 x 15218	3,010
18.306.080.32	80	32	90	72	4 x 15220	3,190
18.306.080.40	80	40	110	80	4 x 15220	3,980
18.306.080.50	80	50	120	100	4 x 15024	3,760
18.306.100.12	100	12	100	42	15212	3,750
18.306.100.16	100	16	100	48	15314	3,930
18.306.100.20	100	20	100	52	15216	4,020
18.306.100.25	100	25	100	65	4 x 15218	4,550
18.306.100.32	100	32	100	72	4 x 15220	4,750
18.306.100.40	100	40	120	80	4 x 15220	5,600
18.306.100.50	100	50	130	100	4 x 15024	7,500



Characteristics:
Mill adaptors.
PSC ISO 26623-1
For frontal end mill support
screwed shanks.

Eigenschaften:
Spannfutter PSC ISO 26623-1
Für Einschraubfräser.

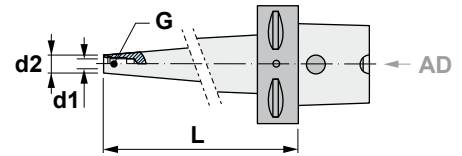

18.315

Reference Bezeichnung	PSC	L	d1	d2	
18.315.040.08	40	70	M8	13	0,310
18.315.040.10	40	80	M10	18	0,390
18.315.040.12	40	80	M12	21	0,430
18.315.050.08	50	70	M8	13	0,490
18.315.050.10	50	80	M10	18	0,570
18.315.050.12	50	80	M12	21	0,610
18.315.050.16	50	80	M16	29	0,750
18.315.063.08	63	70	M8	13	0,770
18.315.063.10	63	90	M10	18	0,880
18.315.063.12	63	100	M12	21	0,980
18.315.063.16	63	100	M16	29	1,170
18.315.080.12	80	100	M12	21	1,950
18.315.080.16	80	100	M16	29	2,110
18.315.100.12	100	120	M12	21	3,590
18.315.100.16	100	120	M16	29	3,560





Characteristics:
Strong hold collet chuck for cylindrical collets.
PSC ISO 26623-1

Eigenschaften:
Kraftspannfutter für zylindrische Spannzangen.
PSC ISO 26623-1

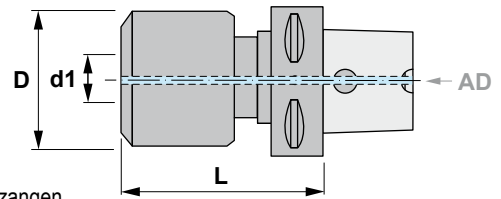

18.400

Reference Bezeichnung	PSC	L	d1	D	
18.400.063.20	63	93	20	54	1,690
18.400.080.20	80	89	20	72	2,490
18.400.080.32	80	101	32	72	3,140
18.400.100.32	100	120	32	72	5,160

Complements (Collets type C) /Zubehör (Spannzangen Typ C)

Reference / Bezeichnung	d	D	L
C2006	6	20	55
C2008	8	20	55
C2010	10	20	55
C2012	12	20	55
C2016	16	20	55
C3206	6	32	65
C3208	8	32	65
C3210	10	32	65
C3212	12	32	65
C3216	16	32	65
C3220	20	32	65
C3225	25	32	65

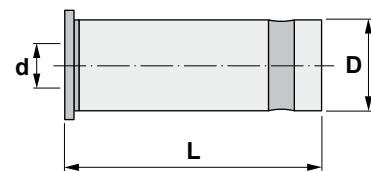



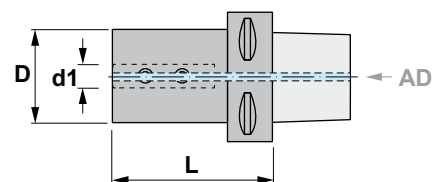

Characteristics:
Boring bar holders.
PSC ISO 26623-1

Eigenschaften:
Bohrstangenaufnahme.
PSC ISO 26623-1



18.406

Reference Bezeichnung	PSC	L	d1	D		
18.406.040.08	40	50	08	44	14206	0,590
18.406.040.10	40	50	10	44	14208	0,580
18.406.040.12	40	50	12	44	14208	0,570
18.406.040.16	40	50	16	44	14210	0,550
18.406.040.20	40	50	20	44	14210	0,510
18.406.040.25	40	60	25	50	14210	0,660
18.406.050.08	50	52	08	44	14206	0,790
18.406.050.10	50	52	10	44	14208	0,780
18.406.050.12	50	52	12	44	14208	0,770
18.406.050.16	50	52	16	44	14210	0,730
18.406.050.20	50	52	20	50	14210	0,820
18.406.050.25	50	60	25	55	14210	1,000
18.406.063.08	63	60	08	44	14206	1,140
18.406.063.10	63	60	10	44	14208	1,130
18.406.063.12	63	60	12	44	14208	1,120
18.406.063.16	63	60	16	44	14210	1,090
18.406.063.20	63	60	20	50	14210	1,190
18.406.063.25	63	72	25	55	14210	1,420
18.406.063.32	63	75	32	55	14210	1,320
18.406.063.40	63	85	40	65	14210	3,260
18.406.080.16	80	85	16	44	14210	2,280
18.406.080.20	80	85	20	50	14210	2,410
18.406.080.25	80	85	25	55	14210	2,490
18.406.080.32	80	85	32	72	17110	3,080
18.406.080.40	80	95	40	65	14210	4,850
18.406.080.50	80	100	50	75	14210	4,680
18.406.100.16	100	100	16	44	14210	3,430
18.406.100.20	100	100	20	50	14210	3,650
18.406.100.25	100	100	25	55	14210	3,900
18.406.100.32	100	100	32	55	17110	4,600
18.406.100.40	100	110	40	65	14210	5,200
18.406.100.50	100	120	50	75	14210	5,580



**Characteristics:**

Collet chucks for DIN 6499 (ER) collets.

PSC ISO 26623-1

For tools with cylindrical shank DIN 1835-B.

* Ball bearing nut, see page: I217

Eigenschaften:





Spannzangenfutter für Spannzangen DIN 6499 (ER).

PSC ISO 26623-1

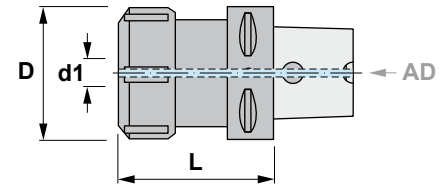
Für Werkzeuge mit zylindrischem Schaft DIN 1835-B.

* Für Kugellager-Mutter, siehe Seite: I217

**18.453***** SUPPLIED WITHOUT WRENCH / LIEFERUNG OHNE SCHLÜSSEL**

Reference Bezeichnung	PSC		L	d1	D			
18.453.040.16	40	ER16	60	0,5-10	28	45316	50216	0,420
18.453.040.20	40	ER20	60	1-13	34	45320	50220	0,490
18.453.040.25	40	ER25	60	1-16	42	45325	50225	0,630
18.453.040.32	40	ER32	60	2-20	50	45332	50232	0,850
18.453.050.16	50	ER16	60	0,5-10	28	45316	50216	0,600
18.453.050.16/100	50	ER16	100	0,5-10	28	45316	50216	0,790
18.453.050.20	50	ER20	60	1-13	34	45320	50220	0,670
18.453.050.20/100	50	ER20	100	1-13	34	45320	50220	0,900
18.453.050.25	50	ER25	60	1-16	42	45325	50225	0,810
18.453.050.25/100	50	ER25	100	1-16	42	45325	50225	1,150
18.453.050.32	50	ER32	60	2-20	50	45332	50232	1,020
18.453.050.32/100	50	ER32	100	2-20	50	45332	50232	1,520
18.453.050.40	50	ER40	65	3-30	63	45340	50240	1,410
18.453.050.40/100	50	ER40	100	3-30	63	45340	50240	1,950
18.453.063.16	63	ER16	60	0,5-10	28	45316	50216	0,870
18.453.063.16/100	63	ER16	100	0,5-10	28	45316	50216	1,060
18.453.063.20	63	ER20	60	1-13	34	45320	50220	0,940
18.453.063.20/100	63	ER20	100	1-13	34	45320	50220	1,170
18.453.063.25	63	ER25	60	1-16	42	45325	50225	1,070
18.453.063.25/100	63	ER25	100	1-16	42	45325	50225	1,410
18.453.063.32	63	ER32	60	2-20	50	45332	50232	1,280
18.453.063.32/100	63	ER32	100	2-20	50	45332	50232	1,810
18.453.063.40	63	ER40	70	3-30	63	45340	50240	1,770
18.453.063.40/120	63	ER40	120	3-30	63	45340	50240	2,740
18.453.080.32	80	ER32	70	2-20	50	45332	50232	2,310
18.453.080.32/160	80	ER32	160	2-20	50	45332	50232	3,420
18.453.080.40	80	ER40	70	3-30	63	45340	50240	2,660
18.453.080.40/160	80	ER40	160	3-30	63	45340	50240	4,350
18.453.100.32	100	ER32	100	2-20	50	45332	50232	3,960
18.453.100.32/160	100	ER32	160	2-20	50	45332	50232	4,780
18.453.100.40	100	ER40	100	3-30	63	45340	50240	4,430
18.453.100.40/160	100	ER40	160	3-30	63	45340	50240	5,690
18.453.100.50	100	ER50	100	6-34	78	45350	50250	5,460
18.453.100.50/160	100	ER50	160	6-34	78	45350	50250	7,190

ERXX  I210-212

Reference / Bez.

ERXX

**ERCXX**  I215-216

Reference / Bez.

ERCXX

**ERTXX**  I217-218

Reference / Bez.

ERTXX

**40.453..**  I180

Reference / Bez.

40.453..

**40.455..**  I181

Reference / Bez.

40.455..





Characteristics:
Long collet chuck for
DIN 6499 (ER) collets.
PSC ISO 26623-1
For tools with cylindrical shank.
With "mini" collet nut.

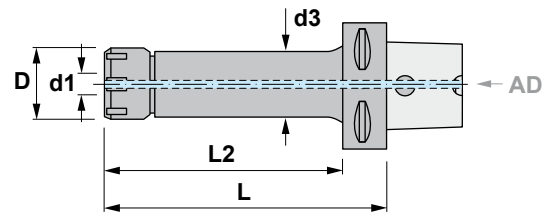

*** SUPPLIED WITHOUT WRENCH**

Eigenschaften:
Lange Spannzangenfutter für
Spannzangen DIN 6499 (ER).
PSC ISO 26623-1
Für Werkzeuge mit zylindrischem Schaft.
Mit "Mini"-Spannmutter.

*** LIEFERUNG OHNE SCHLÜSSEL**

18.455

Reference Bezeichnung	PSC		L	d1	D	L2	d3				
18.455.063.16	63	ER16	60	0,5-10	22	-	-	45516	50916	19210	0,860
18.455.063.16/100	63	ER16	100	0,5-10	22	78	22	45516	50916	19210	0,950
18.455.063.20	63	ER20	60	1-13	28	-	-	45520	50920	19212	0,960
18.455.063.20/100	63	ER20	100	1-13	28	78	30	45520	50920	19212	1,120

ERXX

 I210-212

Ref. / Bez. Accessories / Zubehör

ERXX Collets with double slot DIN 6499 - Form B (ER)
Spannzangen mit Doppelnut DIN 6499 - Form B (ER)



ERCXX

 I215-216

Ref. / Bez. Accessories / Zubehör

ERCXX Sealed collets DIN 6499 (ER)
Abgedichtete Spannzangen DIN 6499 (ER)



ERTXX

 I217-218

Ref. / Bez. Accessories / Zubehör

ERTXX Collets DIN 6499 - Form Mexin (ER)
Spannzangen DIN 6499 - Form Mexin (ER)





Characteristics:
Blank adaptors.
PSC ISO 26623-1

Eigenschaften:
Rohlinge.
PSC ISO 26623-1

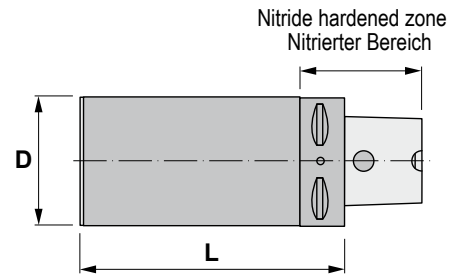

18.470

Reference Bezeichnung	PSC	D	L	 Kg
18.470.032.032/090	32	32	90	0,590
18.470.032.040/110	32	40	110	1,050
18.470.032.050/125	32	50	125	1,810
18.470.032.060/090	32	60	90	1,780
18.470.032.070/060	32	70	60	1,470
18.470.032.090/070	32	90	70	2,860
18.470.040.040/095	40	40	95	0,990
18.470.040.040/120	40	40	120	1,240
18.470.040.060/165	40	60	165	3,460
18.470.040.080/075	40	80	75	2,420
18.470.040.080/120	40	80	120	4,190
18.470.040.100/085	40	100	85	4,260
18.470.050.050/125	50	50	125	2,050
18.470.050.050/150	50	50	150	2,430
18.470.050.063/180	50	63	180	4,340
18.470.050.075/175	50	75	175	5,800
18.470.050.090/080	50	90	80	3,420
18.470.050.095/150	50	95	150	7,660
18.470.050.110/090	50	110	90	5,650
18.470.063.063/180	63	63	180	4,630
18.470.063.075/195	63	75	195	6,710
18.470.063.110/085	63	110	85	5,410
18.470.063.110/120	63	110	120	8,020
18.470.063.120/180	63	120	180	14,730
18.470.063.130/095	63	130	95	8,400
18.470.080.080/200	80	80	200	8,430
18.470.080.100/200	80	100	200	12,200
18.470.080.120/160	80	120	160	13,260
18.470.080.130/090	80	130	90	7,970
18.470.080.150/200	80	150	200	25,300
18.470.080.160/120	80	160	120	15,930
18.470.100.100/100	100	100	100	7,280
18.470.100.100/200	100	100	200	13,450
18.470.100.150/100	100	150	100	12,520
18.470.100.150/200	100	150	200	26,390
18.470.100.160/150	100	160	150	21,710
18.470.100.200/100	100	200	100	19,850



Characteristics:
Adaptor with axial mounting.
PSC ISO 26623-1
Adaptor for square turning toolholder
left / right hand.

Eigenschaften:
Axial-Werkzeughalter.
PSC ISO 26623-1
Dreh-Werkzeughalter für Klemmhalter
links / rechts.

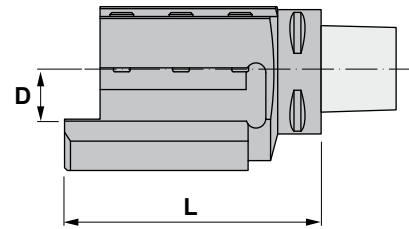

18.500

Reference Bezeichnung	PSC	D	L	
18.500.050.20 R/L	50	20	98	2,050
18.500.063.20 R/L	63	20	100	2,560
18.500.063.25 R/L	63	25	130	3,640
18.500.063.32 R/L	63	32	134	3,990
18.500.080.32 R/L	80	32	140	5,390
18.500.100.32 R/L	100	32	150	10,100

Reference Bezeichnung	3x 	
18.500.050.20 R/L	17010	29708
18.500.063.20 R/L	17110	29708
18.500.063.25 R/L	17012	29708
18.500.063.32 R/L	17012	29708
18.500.080.32 R/L	17012	29710
18.500.100.32 R/L	17012	29710



**Characteristics:**

Adaptor with angular mounting.
PSC ISO 26623-1
Adaptor for square turning toolholder
left / right hand.

Eigenschaften:

Werkzeughalter. Schräge Montage.
PSC ISO 26623-1
Dreh-Werkzeughalter für Klemmhalter
links / rechts.

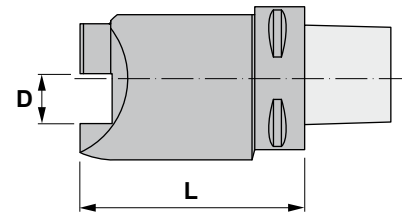

18.510

Reference Bezeichnung	PSC	D	L	 kg
18.510.050.20 R/L	50	20	97	1,770
18.510.063.20 R/L	63	20	99	2,180
18.510.063.25 R/L	63	25	130	4,430
18.510.080.32 R/L	80	32	135	6,680
18.510.100.32 R/L	100	32	145	10,030

Reference Bezeichnung		
18.510.050.20 R/L	17110	29708
18.510.063.20 R/L	17110	29708
18.510.063.25 R/L	17012	29708
18.510.080.32 R/L	17012	29710
18.510.100.32 R/L	17012	29710



Characteristics:
Mini-turret with axial mounting.
PSC ISO 26623-1
Multipurpose mini-turret for square toolholders.

Eigenschaften:
Mehrfach-Axial-Werkzeughalter.
PSC ISO 26623-1
Multifunktionaler Werkzeughalter für vierkantigen Klemmhalter.

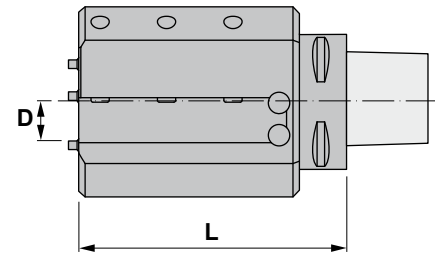

18.520

Reference Bezeichnung	PSC	D	L	
18.520.050.20 R/L	50	20	123	3,770
18.520.063.20 R/L	63	20	125	4,250
18.520.063.25 R/L	63	25	130	5,140
18.520.080.32 R/L	80	32	150	7,780
18.520.100.32 R/L	100	32	160	11,400

Reference Bezeichnung		
18.520.050.20 R/L	17012	29708
18.520.063.20 R/L	17012	29708
18.520.063.25 R/L	17012	29708
18.520.080.32 R/L	17012	29710
18.520.100.32 R/L	17012	29710



**Characteristics:**

Adaptor with radial mounting.
PSC ISO 26623-1
Multipurpose adaptor for square
toolholders.

Eigenschaften:

Radial-Werkzeughalter.
PSC ISO 26623-1
Multifunktionaler Werkzeughalter für
vierkantige Klemmhalter.

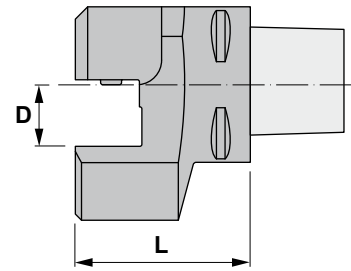

18.530

Reference Bezeichnung	PSC	D	L	
18.530.050.20	50	20	58	1,460
18.530.063.20	63	20	60	1,790
18.530.063.25	63	25	71	2,860
18.530.063.32	63	32	71	3,300
18.530.080.32	80	32	85	4,750
18.530.100.32	100	32	90	6,470

Reference Bezeichnung		
18.530.050.20	17112	29708
18.530.063.20	17112	29708
18.530.063.25	17012	29708
18.530.063.32	17012	29708
18.530.080.32	17012	29710
18.530.100.32	17012	29710



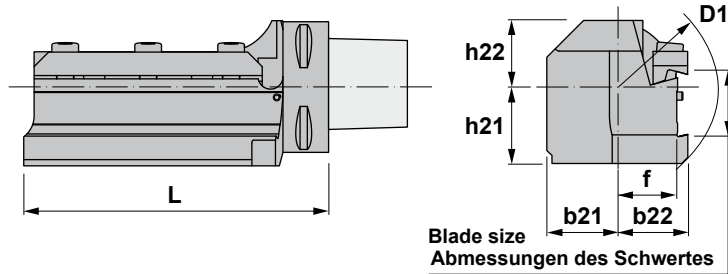

Characteristics:
Adaptor with axial mounting for blades.
PSC ISO 26623-1

Eigenschaften:
Axial-Werkzeughalter für Stechschwerter.
PSC ISO 26623-1



18.540

Reference Bezeichnung	PSC	Blade size Abmessungen des Schwertes	D1	b21	b22	f	h21	h22	L	
18.540.050.26 R/L	50	26	88	25.0	32.0	27.0	30.0	26.0	95	1,500
18.540.063.32 R/L	63	32	106	32.0	39.5	32.0	38.0	32.0	147	3,300
18.540.080.32 R/L	80	32	126	40.5	48.0	40.5	40.5	40.5	155	5,200
18.540.100.32 R/L	100	32	145	50.0	58.0	50.5	50.5	50.0	160	9,240
18.540.100.52 R/L	100	52/53	175	50.0	58.0	50.5	65.0	50.0	200	12,410

Reference Bezeichnung		
18.540.050.26 R/L	80526	11008
18.540.063.32 R/L	80632	11108
18.540.080.32 R/L	80632	11108
18.540.100.32 R/L	80632	11108
18.540.100.52 R/L	81052	11108



**Characteristics:**

Adaptor with radial mounting for blades.
PSC ISO 26623-1

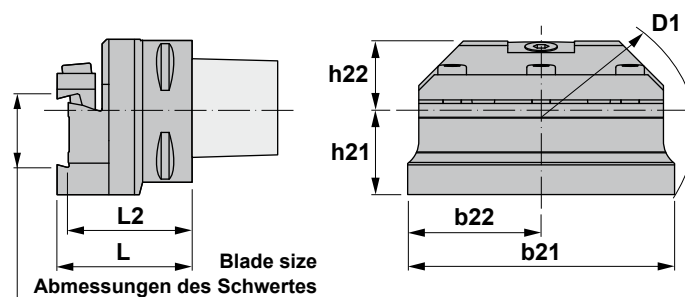

Eigenschaften:

Radial-Werkzeughalter für Stechschwerter.
PSC ISO 26623-1



18.550

Reference Bezeichnung	PSC	Blade size Abmessungen des Schwertes	D1	b21	b22	h21	h22	L	L2	
18.550.050.26	50	26	100	80	40	30.0	25.2	58	53.0	1,300
18.550.063.32	63	32	141	120	60	37.0	32.0	63	55.5	2,300
18.550.080.32	80	32	145	120	60	40.5	40.0	71	63.5	3,500
18.550.100.32	100	32	145	120	60	50.5	50.0	75	67.5	5,570
18.550.100.52	100	52/53	195	160	80	65.0	50.0	75	67.5	6,440

Reference Bezeichnung		
18.550.050.26	80526	11008
18.550.063.32	81632	11108
18.550.080.32	81632	11108
18.550.100.32	81632	11108
18.550.100.52	81052	11108



Characteristics:

Quick change tapping head with axial compensation.
PSC ISO 26623-1
With Bilz system tap chucks bushings.
Compensation in compression (C) and tension (T).

Eigenschaften:

Gewindeschneid-Schnellwechselfutter mit Axial-Längenausgleich.
PSC ISO 26623-1
Mit Gewindebohrer-Buchsen System Bilz.
Ausgleich der Kompression (C) und der Traktion (T).

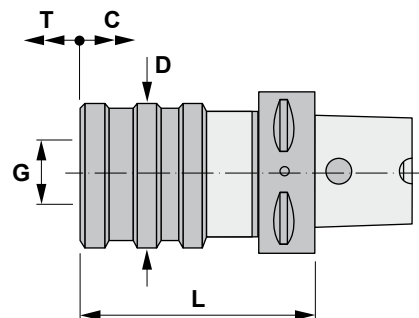

18.620

Reference Bezeichnung	PSC	N°	G Ø	d1	L	D	C	T			
18.620.040.12	40	1	19	M3-M12	65	38	9	9	710XX	750XX	0,510
18.620.050.12	50	1	19	M3-M12	65	38	9	9	710XX	750XX	0,690
18.620.063.12	63	1	19	M3-M12	70	38	9	9	710XX	750XX	0,970
18.620.063.20	63	2	31	M8-M20	95	55	15	15	720XX	760XX	1,710
18.620.063.33	63	3	48	M14-M33	140	79	24	24	730XX	770XX	3,550
18.620.080.12	80	1	19	M3-M12	80	38	9	9	710XX	750XX	2,050
18.620.080.20	80	2	31	M8-M20	100	55	15	15	720XX	760XX	2,720
18.620.080.33	80	3	48	M14-M33	150	79	24	24	730XX	770XX	5,040
18.620.100.12	100	1	19	M3-M12	90	38	9	9	710XX	750XX	3,470
18.620.100.20	100	2	31	M8-M20	110	55	15	15	720XX	760XX	4,180
18.620.100.33	100	3	48	M14-M33	160	79	24	24	730XX	770XX	6,620

710XX..730XX

I202

Ref. / Bezeichnung

Accessories / Zubehör

710XX..730XX

Quick change adapters without overload clutch

Schnellwechseleinsätze ohne Sicherheitskupplung



750XX..770XX

I203

Ref. / Bezeichnung

Accessories / Zubehör

750XX..770XX

Quick change adapters with overload clutch

Schnellwechseleinsätze mit Sicherheitskupplung





Characteristics:
Test arbors.
PSC ISO 26623-1

Eigenschaften:
Prüfdome.
PSC ISO 26623-1

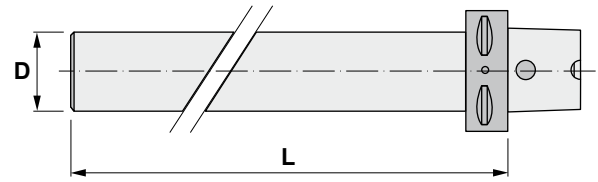

18.999

Reference Bezeichnung	PSC	L	D	 kg
18.999.050	50	255	32	1,910
18.999.063	63	322	40	3,260
18.999.080	80	330	40	4,680





Characteristics:
Adaptor DIN 69871-A
to PSC ISO 26623-1.

Eigenschaften:
Adapter DIN 69871-A
zu PSC ISO 26623-1.

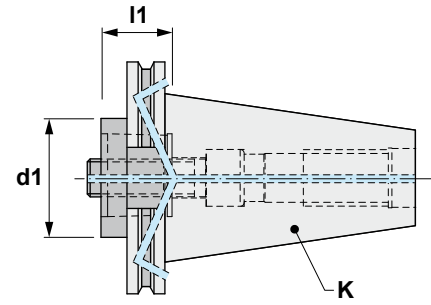

13.218

Reference Bezeichnung	K ISO	PSC	d1	l1	
13.218.30.32/030	30	32	32	30	0,400
13.218.30.32/060	30	32	32	60	0,550
13.218.40.32/030	40	32	32	30	0,850
13.218.40.32/060	40	32	32	60	1,000
13.218.40.40/030	40	40	40	30	0,850
13.218.40.40/060	40	40	40	60	1,100
13.218.40.50/030	40	50	50	30	0,850
13.218.40.50/070	40	50	50	70	1,400
13.218.40.63/085	40	63	63	85	1,900
13.218.50.32/030	50	32	32	30	2,700
13.218.50.32/060	50	32	32	60	3,000
13.218.50.40/030	50	40	40	30	0,850
13.218.50.40/060	50	40	40	60	3,000
13.218.50.50/030	50	50	50	30	2,650
13.218.50.50/070	50	50	50	70	3,210
13.218.50.63/030	50	63	63	30	2,610
13.218.50.63/080	50	63	63	80	3,750
13.218.50.80/070	50	80	80	70	3,900
13.218.50.80/120	50	80	80	120	5,550





Characteristics:
Adaptor HSK DIN 69893-1
to PSC ISO 26623-1.

Eigenschaften:
Adapter HSK DIN 69893-1
zu PSC ISO 26623-1.

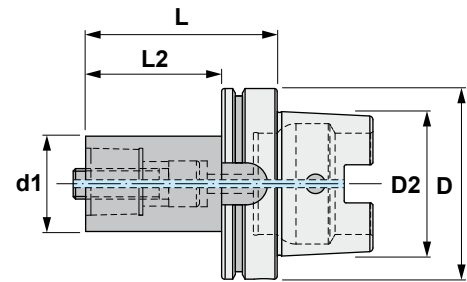

16.218

Reference Bezeichnung	HSK	PSC	d1	D	D2	L	L2	
16.218.063.32/075	63	32	32	63	48	75	49	0,900
16.218.063.40/080	63	40	40	63	48	80	54	1,100
16.218.063.50/090	63	50	50	63	48	90	64	1,450
16.218.100.32/080	100	32	32	100	75	80	51	2,310
16.218.100.40/090	100	40	40	100	75	90	61	2,550
16.218.100.50/100	100	50	50	100	75	100	71	2,950
16.218.100.63/110	100	63	63	100	75	110	81	3,700
16.218.100.80/120	100	80	80	100	75	120	91	4,900





Characteristics:
Extension
PSC ISO 26623-1.

Eigenschaften:
Verlängerung
PSC ISO 26623-1.

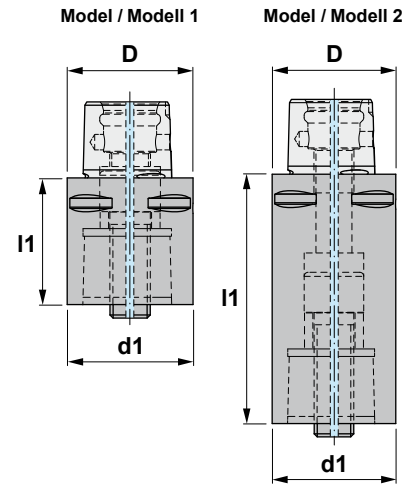

18.218

Reference Bezeichnung	Model Modell	Side PSC / Machine PSC Größe/ Maschine	d1	D	l1	⚖️ Kg
18.218.32.32/035	1	32	32	32	35	0,200
18.218.32.32/060	2	32	32	32	60	0,360
18.218.32.32/080	2	32	32	32	80	0,490
18.218.40.40/040	1	40	40	40	40	0,370
18.218.40.40/060	2	40	40	40	60	0,600
18.218.40.40/080	2	40	40	40	80	0,800
18.218.50.50/050	1	50	50	50	50	0,730
18.218.50.50/080	2	50	50	50	80	1,240
18.218.50.50/100	2	50	50	50	100	1,500
18.218.63.63/060	1	63	63	63	60	1,350
18.218.63.63/100	2	63	63	63	100	2,350
18.218.63.63/140	2	63	63	63	140	3,300
18.218.80.80/065	1	80	80	80	65	2,350
18.218.80.80/100	2	80	80	80	100	3,750
18.218.80.80/125	2	80	80	80	125	4,750





Characteristics:
Reducer
PSC ISO 26623-1.

Eigenschaften:
Reduzierhülse
PSC ISO 26623-1.

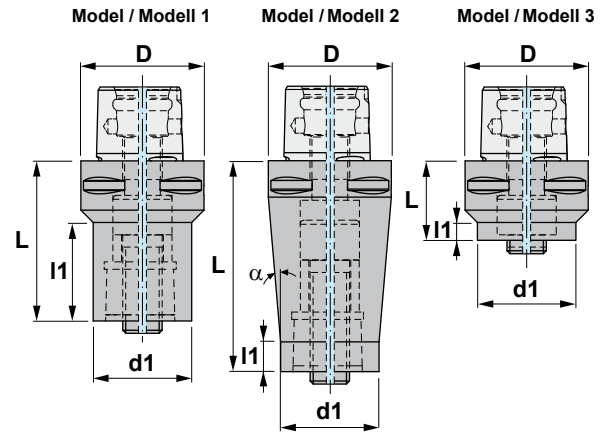

18.218

Reference Bezeichnung	Model Modell	Side Machine PSC Maschine	Side PSC PSC Größe	D	d1	L	l1	α	
18.218.40.32/055	1	40	32	40	32	55	31.0	-	0,430
18.218.40.32/070	2	40	32	40	32	70	12.0	6.0°	0,560
18.218.50.32/060	1	50	32	50	32	60	34.8	-	0,640
18.218.50.40/065	1	50	40	50	40	65	40.0	-	0,800
18.218.50.40/085	2	50	40	50	40	85	12.0	5.4°	1,130
18.218.50.32/033	3	50	32	50	32	33	10.0	-	0,470
18.218.50.40/040	3	50	40	50	40	40	18.0	-	0,550
18.218.63.32/070	1	63	32	63	32	70	39.0	-	0,970
18.218.63.40/080	1	63	40	63	40	80	51.4	-	1,200
18.218.63.50/080	1	63	50	63	50	80	51.5	-	1,500
18.218.63.50/110	2	63	50	63	50	110	12.0	4.9°	2,250
18.218.63.32/032	3	63	32	63	32	32	6.0	-	0,760
18.218.63.40/040	3	63	40	63	40	40	11.0	-	0,800
18.218.63.50/050	3	63	50	63	50	50	26.5	-	1,000
18.218.80.32/060	1	80	32	80	32	60	29.3	-	1,900
18.218.80.40/070	1	80	40	80	40	70	36.5	-	2,000
18.218.80.50/080	1	80	50	80	50	80	49.3	-	2,300
18.218.80.63/080	1	80	63	80	63	80	53.1	-	2,650
18.218.80.63/120	2	80	63	80	63	120	12.0	6.2°	4,300
18.218.80.50/045	3	80	50	80	50	45	10.0	-	1,800
18.218.80.63/055	3	80	63	80	63	55	20.0	-	2,000



Characteristics:
Adaptor JIS B 6339-BT
to PSC ISO 26623-1.

Eigenschaften:
Adapter JIS B 6339-BT
zu PSC ISO 26623-1.

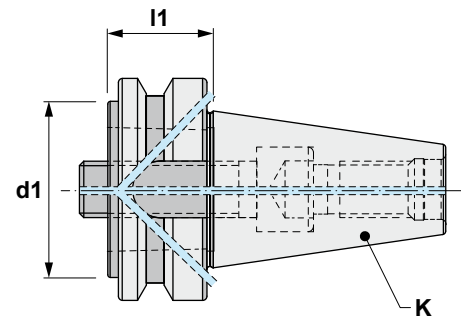

23.218

Reference Bezeichnung	K ISO	PSC	d1	l1	⚖️
23.218.30.32/030	30	32	32	30	0,400
23.218.30.32/060	30	32	32	60	0,600
23.218.40.32/030	40	32	32	30	1,000
23.218.40.32/060	40	32	32	60	1,200
23.218.40.40/030	40	40	40	30	0,950
23.218.40.40/060	40	40	40	60	1,250
23.218.40.50/030	40	50	50	30	0,900
23.218.40.50/070	40	50	50	70	1,500
23.218.40.63/075	40	63	63	75	1,900
23.218.50.32/040	50	32	32	40	3,650
23.218.50.32/070	50	32	32	70	3,850
23.218.50.40/040	50	40	40	40	3,650
23.218.50.40/070	50	40	40	70	3,900
23.218.50.50/040	50	50	50	40	3,550
23.218.50.50/080	50	50	50	80	4,150
23.218.50.63/040	50	63	63	40	3,450
23.218.50.63/090	50	63	63	90	4,650
23.218.50.80/070	50	80	80	70	4,200
23.218.50.80/120	50	80	80	120	6,150





Characteristics:
Arbors for boring heads.
PSC ISO 26623-1

Eigenschaften:
Aufnahmen für Bohrköpfe.
PSC ISO 26623-1

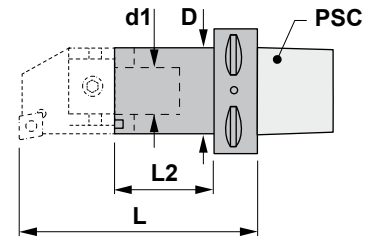

18.700

Reference Bezeichnung	PSC	D	L	L2	d1	Kg
18.700.63.12/055	63	22	77	43	12	0,750
18.700.63.12/110	63	22	132	98	12	0,920
18.700.63.15/065	63	27	87	45	15	0,880
18.700.63.15/110	63	27	132	90	15	1,080
18.700.63.20/075	63	32	97	52	20	1,000
18.700.63.20/120	63	32	142	97	20	1,280

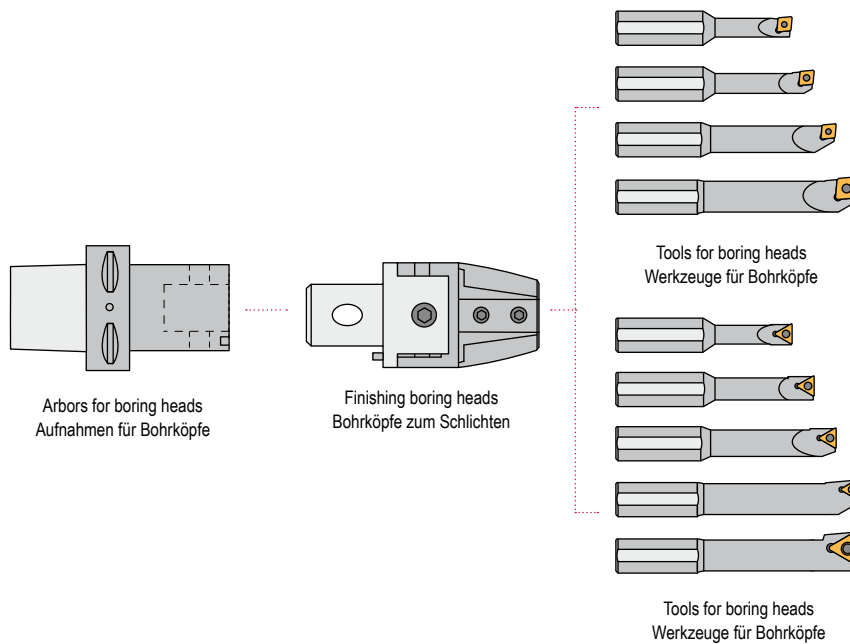
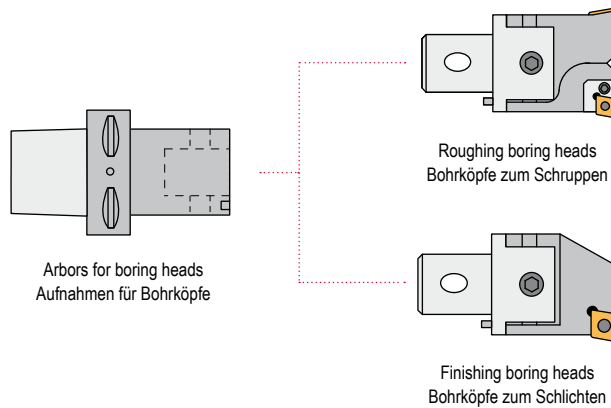



Characteristics:
Manual caps.

Eigenschaften:
Manuelle Verschußstopfen.

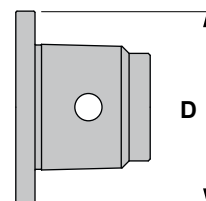

MC

Reference Bezeichnung	Manual Cap Manuelle Verschußstopfen	
PSC32-MC	32	0,080
PSC40-MC	40	0,150
PSC50-MC	50	0,180
PSC63-MC	63	0,420
PSC80-MC	80	1,000



E



Characteristics:
Automatic caps.

Eigenschaften:
Automatische Verschußstopfen.

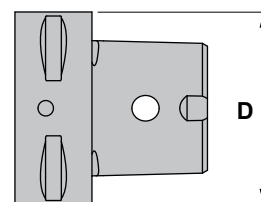

AC

Reference Bezeichnung	Automatic Cap Automatische Verschußstopfen	
PSC40-AC	40	0,250
PSC50-AC	50	0,445
PSC63-AC	63	0,700
PSC80-AC	80	1,700

