



# DIN 2080

Code system Kodifizierung	<b>I02</b>
Technical information Technische Auskünfte	<b>I03</b>
Applications index Anwendungen	<b>I04</b>
Arbors and adaptors DIN 2080 Aufnahmen DIN 2080	<b>I05-24</b>
Special tool request Sonderwerkzeug-Anfrage	<b>I25</b>



## Code system / Kodifizierung

<b>10</b>	<b>160</b>	<b>30</b>	<b>16</b>
<b>1</b>	<b>2</b>	<b>3</b>	<b>4</b>

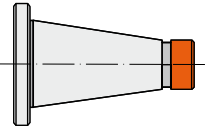
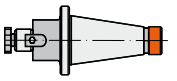
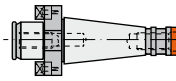
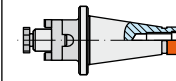
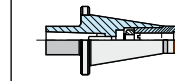
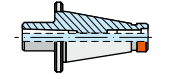
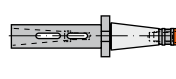
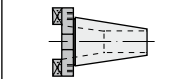
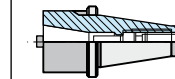
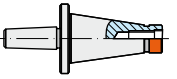
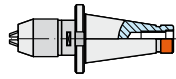
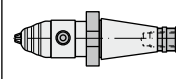
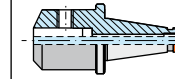
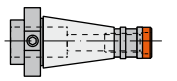
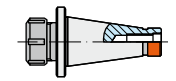
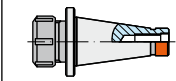
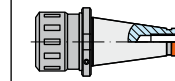
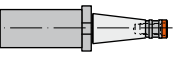
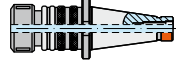
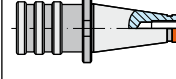
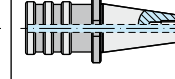
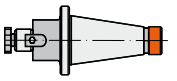
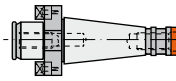
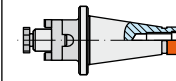
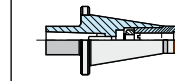
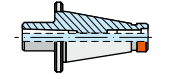
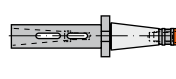
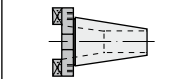
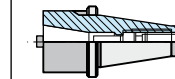
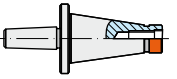
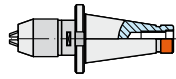
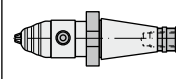
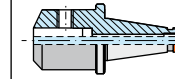
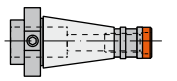
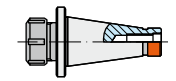
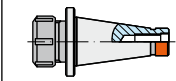
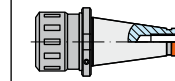
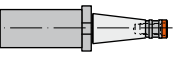
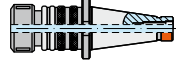
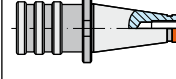
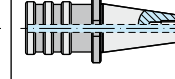
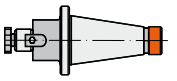
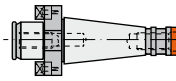
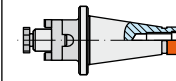
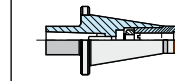
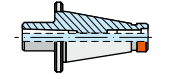
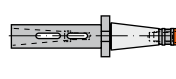
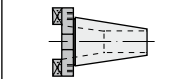
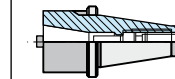
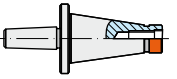
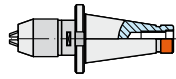
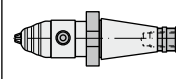
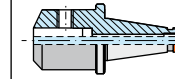
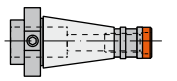
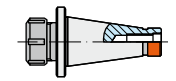
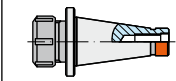
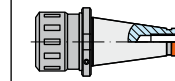
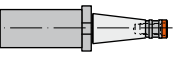
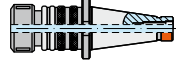
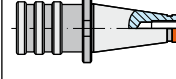
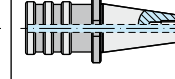
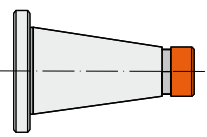
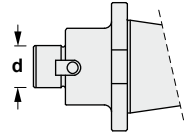
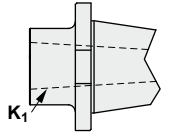
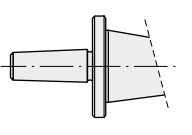
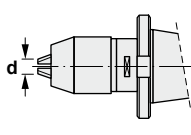
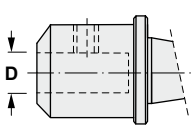
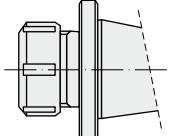
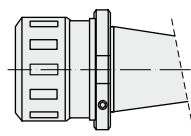
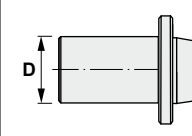
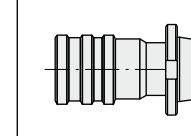
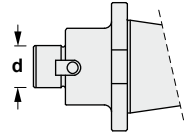
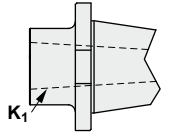
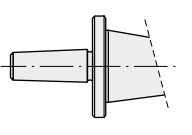
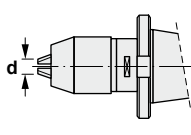
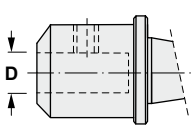
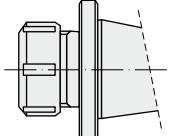
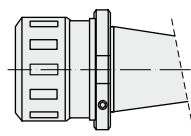
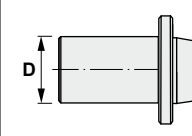
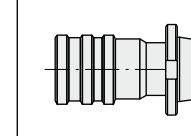
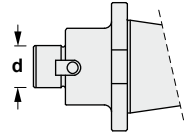
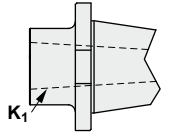
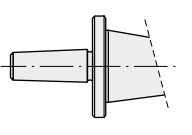
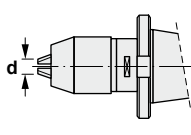
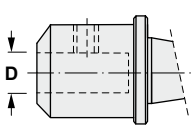
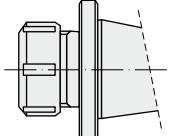
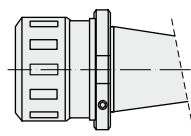
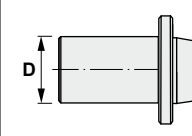
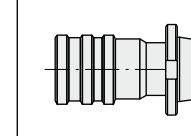
<b>1 Model Modell</b>  10 DIN 2080		<b>2 Arbor type Aufnahmen-Typ</b> <table border="1"> <tr> <td></td> <td></td> <td></td> <td></td> </tr> <tr> <td>160</td> <td>165</td> <td>180</td> <td>210</td> </tr> <tr> <td></td> <td></td> <td></td> <td></td> </tr> <tr> <td>215</td> <td>216</td> <td>220</td> <td>225</td> </tr> <tr> <td></td> <td></td> <td></td> <td></td> </tr> <tr> <td>290</td> <td>295</td> <td>296</td> <td>300</td> </tr> <tr> <td></td> <td></td> <td></td> <td></td> </tr> <tr> <td>302</td> <td>353</td> <td>453</td> <td>457</td> </tr> <tr> <td></td> <td></td> <td></td> <td></td> </tr> <tr> <td>470</td> <td>610</td> <td>620</td> <td>630</td> </tr> </table>																160	165	180	210					215	216	220	225					290	295	296	300					302	353	453	457					470	610	620	630
																																																					
160	165	180	210																																																		
																																																					
215	216	220	225																																																		
																																																					
290	295	296	300																																																		
																																																					
302	353	453	457																																																		
																																																					
470	610	620	630																																																		
<b>3 Arbor size Aufnahmengröße</b> ISO  DIN 2080 ISO 30 <b>30</b> ISO 40 <b>40</b> ISO 50 <b>50</b>																																																					
<b>4 Adaptor size Adaptergröße</b> <table border="1"> <tr> <td colspan="4">                   K<sub>1</sub> - MORSE                  Ø 16   Ø 22   Ø 27   Ø 32   Ø 40   Ø 60  <b>16</b>   <b>22</b>   <b>27</b>   <b>32</b>   <b>40</b>   <b>60</b> </td> <td colspan="4">                   K<sub>1</sub> - ISO                  ISO 30    ISO 40  <b>30</b>    <b>40</b> </td> <td colspan="3">                   B12    B16    B18  <b>12</b>    <b>16</b>    <b>18</b> </td> <td colspan="3">                   Ø 8    Ø 13    Ø 16  <b>8</b>    <b>13</b>    <b>16</b> </td> </tr> <tr> <td colspan="4">                   Ø 6 ... Ø 50  <b>6 ... 50</b> </td> <td colspan="4">                   ER16   ER20   ER25   ER32   ER40  <b>16</b>   <b>20</b>   <b>25</b>   <b>32</b>   <b>40</b> </td> <td colspan="3">                   ER16   ER20   ER25   ER32   ER40  <b>16</b>   <b>20</b>   <b>25</b>   <b>32</b>   <b>40</b> </td> <td colspan="3">                   Ø 50   Ø 63   Ø 80   Ø 85   Ø 90  <b>50</b>   <b>63</b>   <b>80</b>   <b>85</b>   <b>90</b> </td> <td colspan="3">                   M3-M12   M4-M20   M8-M33  <b>12</b>   <b>20</b>   <b>33</b> </td> </tr> </table>												 K <sub>1</sub> - MORSE Ø 16   Ø 22   Ø 27   Ø 32   Ø 40   Ø 60 <b>16</b>   <b>22</b>   <b>27</b>   <b>32</b>   <b>40</b>   <b>60</b>				 K <sub>1</sub> - ISO ISO 30    ISO 40 <b>30</b> <b>40</b>				 B12    B16    B18 <b>12</b> <b>16</b> <b>18</b>			 Ø 8    Ø 13    Ø 16 <b>8</b> <b>13</b> <b>16</b>			 Ø 6 ... Ø 50 <b>6 ... 50</b>				 ER16   ER20   ER25   ER32   ER40 <b>16</b>   <b>20</b>   <b>25</b>   <b>32</b>   <b>40</b>				 ER16   ER20   ER25   ER32   ER40 <b>16</b>   <b>20</b>   <b>25</b>   <b>32</b>   <b>40</b>			 Ø 50   Ø 63   Ø 80   Ø 85   Ø 90 <b>50</b>   <b>63</b>   <b>80</b>   <b>85</b>   <b>90</b>			 M3-M12   M4-M20   M8-M33 <b>12</b>   <b>20</b>   <b>33</b>													
 K <sub>1</sub> - MORSE Ø 16   Ø 22   Ø 27   Ø 32   Ø 40   Ø 60 <b>16</b>   <b>22</b>   <b>27</b>   <b>32</b>   <b>40</b>   <b>60</b>				 K <sub>1</sub> - ISO ISO 30    ISO 40 <b>30</b> <b>40</b>				 B12    B16    B18 <b>12</b> <b>16</b> <b>18</b>			 Ø 8    Ø 13    Ø 16 <b>8</b> <b>13</b> <b>16</b>																																										
 Ø 6 ... Ø 50 <b>6 ... 50</b>				 ER16   ER20   ER25   ER32   ER40 <b>16</b>   <b>20</b>   <b>25</b>   <b>32</b>   <b>40</b>				 ER16   ER20   ER25   ER32   ER40 <b>16</b>   <b>20</b>   <b>25</b>   <b>32</b>   <b>40</b>			 Ø 50   Ø 63   Ø 80   Ø 85   Ø 90 <b>50</b>   <b>63</b>   <b>80</b>   <b>85</b>   <b>90</b>			 M3-M12   M4-M20   M8-M33 <b>12</b>   <b>20</b>   <b>33</b>																																							

## AT3 TECHNICAL CHARACTERISTICS OF THE TOOLHOLDERS AT3 TECHNISCHE EIGENSCHAFTEN DER AUFNAHMEN

### MATERIAL:

- Chromium-manganese carburised steel 1.7131 (16MnCr5).

### EXECUTION:

- Carburised, hardened and tempered.
- Surface hardness HRC 58±2 (670±40 HV30)
- Depth of carburised layer minimum 0,5 mm.
- Tensile strength in core minimum 800 N/mm2 after carburizing.

### ACCURACY:

- Taper according to DIN 254
- Taper angle:  
tolerance AT 3 DIN 7178 part 1 and DIN 2080 part 1.
- Other tolerances according to DIN 7160 and 7168.
- Taper surface roughness RZ<0,001 mm.

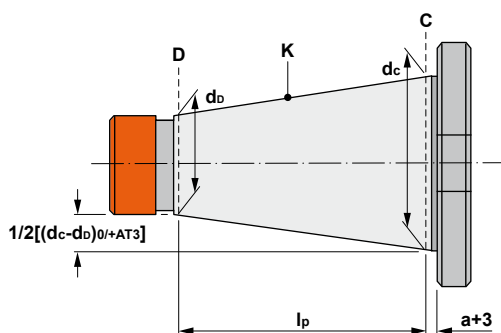

### TOLERANCE AT:

- Indicates the tolerance of measuring plane D between the real and the theoretical value of the taper conicity.
- This value of measuring plane D must always be less (negative), never more (positive) in order to GUARANTEE a good toolholder fixation at the bigger taper diameter.

### MATERIALIEN:

- Legierter aufgekohlter Stahl mit Chrom-Mangan 1.7131 (16MnCr5).

### KONSTRUKTIONS DATEN:

- Aufgekühlt, gehärtet und angelassen.
- Oberflächenhärte HRC 58±2 (670±40 HV30)
- Aufgekühlt auf minimum 0,5 mm Tiefe.
- Zugfestigkeit im Kern minimum 800 N/mm2 nach der Aufkohlung.

### GENAUIGKEIT:

- Dorn nach DIN 254
- Kegelwinkel:  
Toleranz AT 3 DIN 7178 Teil 1 und DIN 2080 Teil 1.
- Andere Toleranzen entsprechend DIN 7160 und 7168.
- Rauigkeit der Oberfläche RZ<0,001 mm.

K	AT3 mm
ISO 30	0,002
ISO 40	0,003
ISO 45	0,003
ISO 50	0,004
ISO 60	0,005

### TOLERANZ AT:

- Zeigt die Toleranz auf der Messebene D zwischen dem tatsächlichen Wert der Kegelkonizität und dem theoretischen Wert.
- Dieser Wert auf der Messebene D sollte immer minus (negativ) sein, nie plus (positiv), um für einen guten Halt des Futter in den größeren Durchmesser des Kegels zu GARANTIEREN.

## 10 DIN 2080

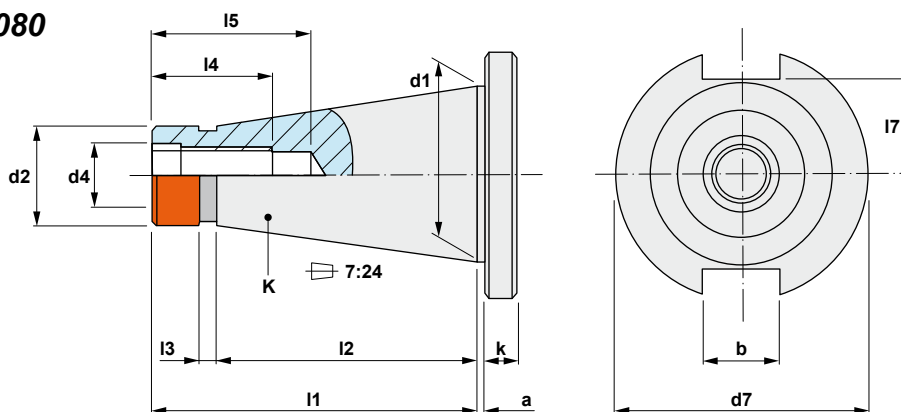

K	a ±0,2	b H12	d1	d2	d4	d7	k	l1	l2	l3	l4	l5 min	l7 max
30	1,6	16,1	31,75	17,4	M12	50,0	8	68,4	48,4	3	24	33,5	16,2
40	1,6	16,1	44,45	25,3	M16	63,0	10	93,4	65,4	5	32	42,5	22,5
45	3,2	19,3	57,15	32,4	M20	80,0	12	106,8	82,8	6	40	52,5	29,0
50	3,2	25,7	69,85	39,6	M24	97,5	12	126,8	101,8	8	47	61,5	35,3
60	3,2	25,7	107,95	60,2	M30	156,0	16	206,8	161,8	10	59	76,0	60,0

**Arbors and adaptors DIN 2080**  
**Aufnahmen DIN 2080**

**10.160**



Page / Seite 105

**10.165**



Page / Seite 106

**10.180**



Page / Seite 107

**10.210**



Page / Seite 108

**10.215**



Page / Seite 109

**10.216**



Page / Seite 110

**10.220**



Page / Seite 111

**10.225**



Page / Seite 112

**10.290**



Page / Seite 113

**10.295**



Page / Seite 114

**10.296**



Page / Seite 115

**10.300**



Page / Seite 116

**10.302**



Page / Seite 117

**10.353**



Page / Seite 118

**10.453**



Page / Seite 119

**10.457**



Page / Seite 120

**10.470**



Page / Seite 121

**10.610**



Page / Seite 122

**10.620**



Page / Seite 123





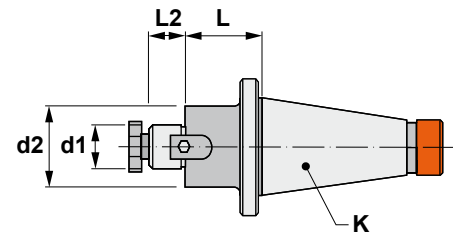

**Characteristics:**  
Shell mill adaptor.  
DIN 2080 / ISO 3937  
For cutters with driving  
slot DIN 138.

**Eigenschaften:**  
Aufsteckfräsdorne.  
DIN 2080 / ISO 3937  
Für Fräser mit Quernut DIN 138.



## 10.160

Reference Bezeichnung	K ISO	d1 h6	L	L2	d2				
10.160.30.16	30	16	30	17	38	10008	86016	11103	0,480
10.160.30.22	30	22	30	19	48	10010	86022	11004	0,570
10.160.30.27	30	27	30	21	58	10012	86027	11005	0,700
10.160.30.32	30	32	35	24	78	10016	86032	11105	0,840
10.160.40.16	40	16	30	17	38	10008	86016	11103	0,950
10.160.40.16/100	40	16	100	17	38	10008	86016	11103	1,370
10.160.40.22	40	22	30	19	48	10010	86022	11004	1,040
10.160.40.22/100	40	22	100	19	48	10010	86022	11004	1,830
10.160.40.27	40	27	30	21	58	10012	86027	11005	1,160
10.160.40.27/100	40	27	100	21	58	10012	86027	11005	2,310
10.160.40.32	40	32	35	24	63	10016	86032	11105	1,320
10.160.40.32/125	40	32	125	24	63	10016	86032	11105	3,134
10.160.40.40	40	40	40	27	73	10020	86040	11006	1,620
10.160.50.16	50	16	35	17	38	10008	86016	11103	2,840
10.160.50.22	50	22	35	19	48	10010	86022	11004	2,950
10.160.50.27	50	27	35	21	58	10012	86027	11005	3,070
10.160.50.27/150	50	27	150	21	58	10012	86027	11005	5,070
10.160.50.32	50	32	40	24	63	10016	86032	11105	3,230
10.160.50.32/150	50	32	150	24	63	10016	86032	11105	6,370
10.160.50.40	50	40	40	27	73	10020	86040	11006	3,990
10.160.50.50	50	50	40	30	90	10024	86050	11008	3,990



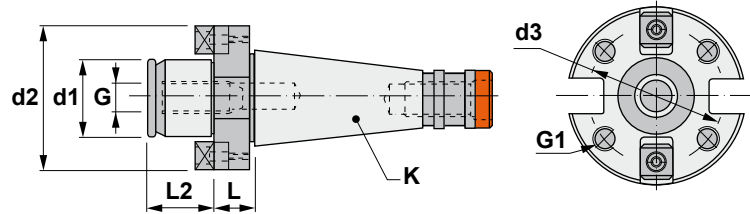

Characteristics:  
Adaptor for indexable milling cutters.  
DIN 2080 / DIN 6357 - Form A

Eigenschaften:  
Zwischenhülsen für Fräser.  
DIN 2080 / DIN 6357 - Form A



## 10.165

Reference Bezeichnung	K ISO	d1 g5	L	d2	d3	G	G1	L2	
10.165.40.40	40	40	20	89	66,7	M-20	M-12	30	1,410
10.165.50.40	50	40	30	89	66,7	M-20	M-12	30	3,430
10.165.50.60	50	60	30	129	101,6	M-30	M-16	40	4,210

Reference Bezeichnung	2x 	2x 
10.165.40.40	80040	11006
10.165.50.40	80040	11006
10.165.50.60	80060	11012

**Characteristics:**



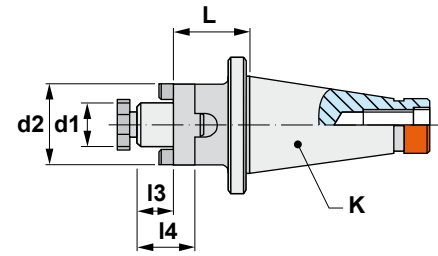

Combi-Shell mill adaptor.  
DIN 2080 / DIN 6358 - Form A  
For cutters with keyway or driving slot DIN 138.

**Eigenschaften:**

Kombi-Aufsteckfräsdorne  
DIN 2080 / DIN 6358 - Form A  
Für Fräser mit Längsnut  
oder Stirnmitnehmer DIN 138.



## 10.180

Reference Bezeichnung	K ISO	d1 h6	L	I3	I4	d2				
10.180.30.16	30	16	35	17	27	32	10008	60116	88016	0,560
10.180.30.22	30	22	35	19	31	40	10010	60122	88022	0,690
10.180.30.27	30	27	35	21	33	48	10012	60127	88027	0,830
10.180.30.32	30	32	50	24	38	58	10016	60132	88032	1,360
10.180.40.16	40	16	52	17	27	32	10008	60116	88016	1,130
10.180.40.16/125	40	16	125	17	27	32	10008	60116	88016	1,670
10.180.40.22	40	22	52	19	31	40	10010	60122	88022	1,310
10.180.40.27	40	27	52	21	33	48	10012	60127	88027	1,530
10.180.40.27/125	40	27	125	21	33	48	10012	60127	88027	2,930
10.180.40.32	40	32	52	24	38	58	10016	60132	88032	1,840
10.180.40.32/125	40	32	125	24	38	58	10016	60132	88032	3,390
10.180.40.40	40	40	52	27	41	70	10020	60140	88040	2,430
10.180.50.16	50	16	55	17	27	32	10008	60116	88016	3,120
10.180.50.16/125	50	16	125	17	27	32	10008	60116	88016	3,650
10.180.50.22	50	22	55	19	31	40	10010	60122	88022	3,340
10.180.50.22/125	50	22	125	19	31	40	10010	60122	88022	3,650
10.180.50.22/200	50	22	200	19	31	40	10010	60122	88022	5,130
10.180.50.27	50	27	55	21	33	48	10012	60127	88027	3,520
10.180.50.27/125	50	27	125	21	33	48	10012	60127	88027	4,860
10.180.50.27/200	50	27	200	21	33	48	10012	60127	88027	6,220
10.180.50.32	50	32	55	24	38	58	10016	60132	88032	3,830
10.180.50.32/125	50	32	125	24	38	58	10016	60132	88032	5,980
10.180.50.32/200	50	32	200	24	38	58	10016	60132	88032	8,280
10.180.50.40	50	40	55	27	41	70	10020	60140	88040	4,420
10.180.50.40/125	50	40	125	27	41	70	10020	60140	88040	6,770
10.180.50.50	50	50	55	30	46	90	10024	60150	88050	4,400





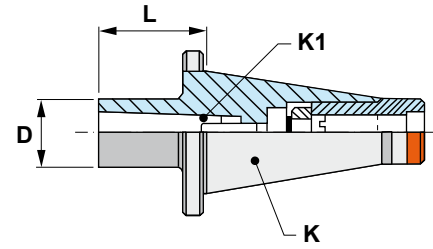

Characteristics:  
Reducing adaptors.  
DIN 2080 / DIN 6364 - Form A ISO 5415  
For tools with Morse taper shank and  
drawbar thread DIN 228-A.

Eigenschaften:  
Reduzierhülsen.  
DIN 2080 / DIN 6364 - Form A ISO 5415  
Für Werkzeuge mit Morsekegel und  
Anzugsgewinde DIN 228-A.



## 10.210

Reference Bezeichnung	K ISO	K1 MORSE	L	D	
10.210.30.01	30	1	50	25	0,480
10.210.30.02	30	2	50	32	0,570
10.210.30.03	30	3	76	40	0,750
10.210.40.01	40	1	50	25	0,940
10.210.40.02	40	2	50	32	0,940
10.210.40.03	40	3	65	40	1,110
10.210.40.04	40	4	95	48	1,520
10.210.50.01	50	1	60	25	2,940
10.210.50.02	50	2	60	32	2,960
10.210.50.03	50	3	65	40	3,020
10.210.50.04	50	4	65	48	3,070
10.210.50.05	50	5	100	63	3,540

Reference Bezeichnung			
10.210.30.01	16004	19312	11406
10.210.30.02	16005	19315	12110
10.210.30.03	16005	19318	12012
10.210.40.01	16105	19516	11506
10.210.40.02	16205	19416	12110
10.210.40.03	16205	19420	11312
10.210.40.04	16205	19322	12016
10.210.50.01	16205	19624	11206
10.210.50.02	16205	19324	11210
10.210.50.03	16205	19524	11512
10.210.50.04	16205	19424	12016
10.210.50.05	16205	19338	11020





**Characteristics:**  
Reducing adaptors.  
DIN 2080 / DIN 6383 - ISO 4202  
For tools with Morse taper shank  
and tang according to DIN 228-B.

**Eigenschaften:**  
Reduzierhülsen.  
DIN 2080 / DIN 6383 - ISO 4202  
Für Werkzeuge mit Morsekegel  
und Austreiblappen nach DIN  
228-B.

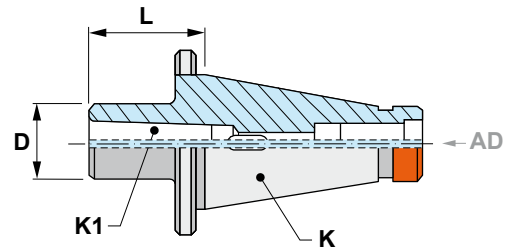

## 10.215

Reference Bezeichnung	K ISO	K1 MORSE	L	D	
10.215.30.01	30	1	50	25	0,470
10.215.30.02	30	2	50	32	0,490
10.215.30.03	30	3	76	40	0,720
10.215.40.01	40	1	50	25	0,870
10.215.40.02	40	2	50	32	0,900
10.215.40.03	40	3	65	40	1,050
10.215.40.04	40	4	95	48	1,380
10.215.50.01	50	1	45	25	2,790
10.215.50.02	50	2	60	32	2,890
10.215.50.03	50	3	65	40	2,920
10.215.50.04	50	4	70	48	2,940
10.215.50.05	50	5	105	63	3,370



**Characteristics:**

Long reducing adaptors. DIN 2080 For tools with Morse taper shank and tang according to DIN 228-B.

**Eigenschaften:**

Lange Reduzierhülsen. DIN 2080 Für Werkzeuge mit Morsekegel und Austreiblappen nach DIN 228-B.

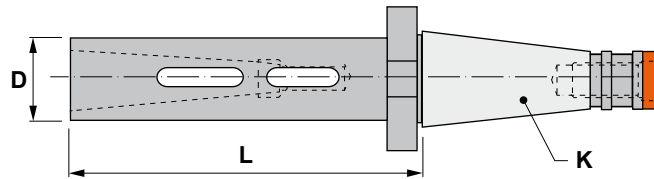

## 10.216

Reference Bezeichnung	K ISO	K1 MORSE	L	D	
10.216.40.02	40	2	110	32	1,320
10.216.40.03	40	3	135	40	1,720
10.216.40.04	40	4	160	48	2,240
10.216.50.02	50	2	115	32	3,290
10.216.50.03	50	3	140	40	3,740
10.216.50.04	50	4	165	48	4,270
10.216.50.05	50	5	215	63	6,000



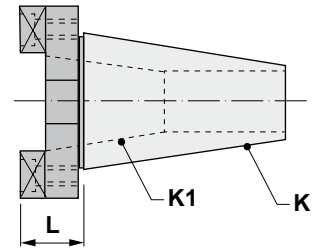

**Characteristics:**  
Reducing adaptors.  
DIN 2080  
For tools with DIN 2080 ISO  
taper shank.

**Eigenschaften:**  
Reduzierhülsen.  
DIN 2080  
Für Werkzeuge mit DIN 2080  
ISO Kegel.



## 10.220

Reference Bezeichnung	K ISO	K1 ISO	L	
10.220.40.30	40	30	19	0,740
10.220.50.30	50	30	23	2,580
10.220.50.40	50	40	23	2,470

Reference Bezeichnung	2x 	2x 
10.220.40.30	80440	11006
10.220.50.30	80440	11006
10.220.50.40	80440	11006







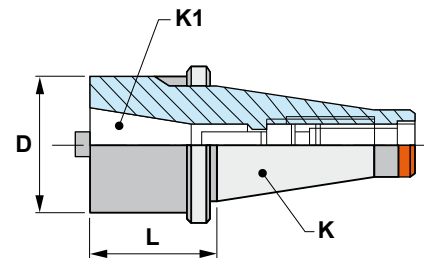

Characteristics:  
Reducing adaptors.  
DIN 2080  
For tools with DIN 2080 ISO  
taper shank.

Eigenschaften:  
Reduzierhülsen.  
DIN 2080  
Für Werkzeuge mit DIN 2080  
ISO Kegel.



## 10.225

Reference Bezeichnung	K ISO	K1 ISO	L	D	
10.225.40.30	40	30	50	50	1,190
10.225.50.30	50	30	50	50	3,050
10.225.50.40	50	40	50	63	3,140

Reference Bezeichnung			
10.225.40.30	16205	19420	11312
10.225.50.30	16205	19524	11512
10.225.50.40	16205	19424	12016



**Characteristics:**  
Drill chuck adaptors.  
DIN 2080  
For drill chucks with DIN 238 taper.

**Eigenschaften:**  
Bohrfutteraufnahmen.  
DIN 2080  
Für Bohrfutter mit DIN 238 Kegel.

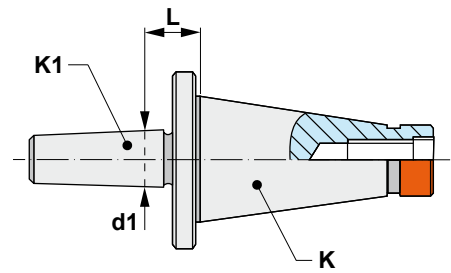

## 10.290

Reference Bezeichnung	K ISO	K1 DIN 238	L	d1	
10.290.30.12	30	B-12	15	12,065	0,390
10.290.30.16	30	B-16	15	15,733	0,380
10.290.30.18	30	B-18	15	17,780	0,360
10.290.40.12	40	B-12	17	12,065	0,860
10.290.40.16	40	B-16	17	15,733	0,880
10.290.40.18	40	B-18	17	17,780	0,890
10.290.50.16	50	B-16	20	15,733	2,880
10.290.50.18	50	B-18	20	17,780	2,920

### MU

 I199

Ref. / Bez.      Accessories / Zubehör

MU      Standard keyless drill chucks DIN 238  
Standard Schnellspann-Bohrfutter DIN 238



### MP

 I200

Ref. / Bez.      Accessories / Zubehör

MP      Super precision keyless drill chucks DIN 238  
Höchst-Genauigkeit-Selbstspannbohrfutter DIN 238



### MK

 I201

Ref. / Bez.      Accessories / Zubehör

MK      Super precision keyless drill chucks DIN 238 with gripping tongue  
Höchst-Genauigkeit-Selbstspannbohrfutter DIN 238 mit Schlüsselflächen





Characteristics:  
Self clamping short precision  
drill chucks.  
DIN 2080  
For right turn only.

**\* SUPPLIED WITH WRENCH**

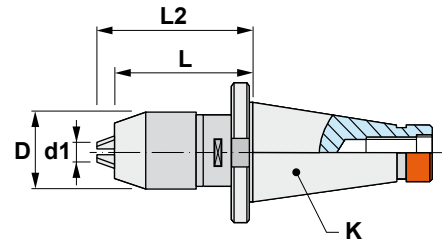

Eigenschaften:  
Selbstspann-Kurzbohrfutter,  
Genauigkeitsausführung.  
DIN 2080  
Nur für rechtslaufende Bearbeitungen.

**\* LIEFERUNG MIT SCHLÜSSEL**



## 10.295

Reference Bezeichnung	K ISO	d1	D	L	L2 max	
10.295.30.08	30	0,3-8	38	70	76	1,000
10.295.40.08	40	0,3-8	38	63	69	1,400
10.295.40.13	40	1-13	48	78	89	1,700
10.295.40.16	40	3-16	55	90	101	2,100
10.295.50.13	50	1-13	48	71	101	3,600
10.295.50.16	50	3-16	55	72	83	3,750

Reference Bezeichnung		
10.295.30.08	50008	11206
10.295.40.08	50008	11206
10.295.40.13	50013	11108
10.295.40.16	50016	11108
10.295.50.13	50013	11108
10.295.50.16	50016	11108



Characteristics:  
CNC-Universal precision  
drill chucks.  
DIN 2080  
For left and right hand turn.

**\* SUPPLIED WITH WRENCH**

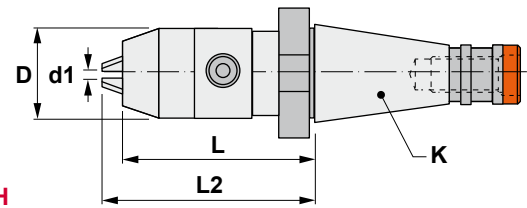

Eigenschaften:  
CNC-Universal Bohrfutter,  
Genauigkeitausführung.  
DIN 2080  
Für links- und rechtslaufende  
Bearbeitungen.

**\* LIEFERUNG MIT SCHLÜSSEL**



## 10.296

Reference Bezeichnung	K ISO	d1	D	L	L2 max	
10.296.40.13	40	1-13	54	82	91	1,840
10.296.40.16	40	3-16	57	85	92	2,000
10.296.50.13	50	1-13	54	85	94	3,320
10.296.50.16	50	3-16	57	88	95	3,420

Reference Bezeichnung		3x 
10.296.40.13	5006	60313
10.296.40.16	5006	60313
10.296.50.13	5006	60313
10.296.50.16	5006	60313





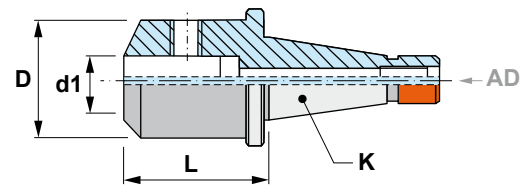

**Characteristics:**  
Weldon end mill adaptor.  
DIN 2080 / DIN 6359  
Form A ISO 5414  
For cutters with cylindrical shank and Weldon flat DIN 1835-B.



**Eigenschaften:**  
Zylinderschaft-Aufnahme Weldon.  
DIN 2080 / DIN 6359  
Form A ISO 5414  
Für Fräser mit zylindrischem Schaft und Weldon-Fläche DIN 1835-B.

## 10.300

Reference Bezeichnung	K ISO	d1 h4	L	D		
10.300.30.06	30	6	40	25	15106	0,410
10.300.30.08	30	8	40	28	15108	0,430
10.300.30.10	30	10	40	35	15110	0,500
10.300.30.12	30	12	40	42	15212	0,560
10.300.30.14	30	14	40	44	15212	0,580
10.300.30.16	30	16	50	48	15314	0,750
10.300.30.18	30	18	50	50	15314	0,760
10.300.40.06	40	6	50	25	15106	0,880
10.300.40.08	40	8	50	28	15108	0,950
10.300.40.10	40	10	50	35	15110	1,010
10.300.40.12	40	12	50	42	15212	1,110
10.300.40.14	40	14	63	44	15212	1,290
10.300.40.16	40	16	63	48	15314	1,370
10.300.40.18	40	18	63	50	15314	1,400
10.300.40.20	40	20	63	52	15216	1,410
10.300.40.25	40	25	80	65	2 x 15218	2,180
10.300.40.32	40	32	80	72	2 x 15220	2,550
10.300.40.40	40	40	102	90	2 x 15220	4,120
10.300.50.06	50	6	63	25	15106	2,850
10.300.50.08	50	8	63	28	15108	2,890
10.300.50.10	50	10	63	35	15110	2,940
10.300.50.12	50	12	63	42	15212	3,140
10.300.50.14	50	14	63	44	15212	3,130
10.300.50.16	50	16	63	48	15314	3,180
10.300.50.18	50	18	63	50	15314	3,220
10.300.50.20	50	20	63	52	15216	3,270
10.300.50.25	50	25	80	65	2 x 15218	3,980
10.300.50.32	50	32	80	72	2 x 15220	4,210
10.300.50.40	50	40	90	90	2 x 15220	5,310
10.300.50.50	50	50	100	98	2 x 15024	6,060

## 42.300

 1182

Ref. / Bez.      Accessories / Zubehör

42.300      Short and long reducing bushings DIN 1835-B Form A and B  
Kurze und lange Reduzierhülsen DIN 1835-B Form A und B





**Characteristics:**

Short end mill adaptor.

DIN 2080

For cutters and tooling with cylindrical shank and Weldon flat DIN 1835-B.

**Eigenschaften:**



Kurze Aufsteckfräsdorne.

DIN 2080

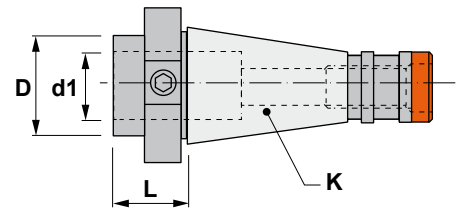
Für Fräser und Werkzeuge mit zylindrischem Schaft und Weldon-Fläche DIN 1835-B.



## 10.302

Reference Bezeichnung	K ISO	d1 h4	L	D		
10.302.30.16	30	16	20	32	15114	0,400
10.302.30.20	30	20	34	36	15014	0,390
10.302.40.16	40	16	22	44	15214	0,850
10.302.40.20	40	20	22	44	15116	0,800
10.302.40.25	40	25	22	44	15016	0,710
10.302.50.16	50	16	16	-	15314	2,710
10.302.50.20	50	20	16	-	15216	2,640
10.302.50.25	50	25	16	-	15118 + 15218	2,540
10.302.50.32	50	32	16	-	15020 + 15120	2,330

### 42.610

 I183

Ref. / Bez.

Accessories / Zubehör

42.610

Tapping head with axial compensation DIN 1835-B

Gewindeschneidfutter mit Längenausgleich DIN 1835-B



### 42.620

 I184

Ref. / Bez.

Accessories / Zubehör

42.620

Quick change tapping head with axial compensation DIN 1835-B+E

Gewindeschneid-Schnellwechselfutter mit Längenausgleich DIN 1835-B + E





Characteristics:  
Collet chucks for DIN 6388 collets.  
DIN 2080  
For tools with cylindrical shank  
DIN 1835-B.  
\* Ball bearing nut, see page: I220

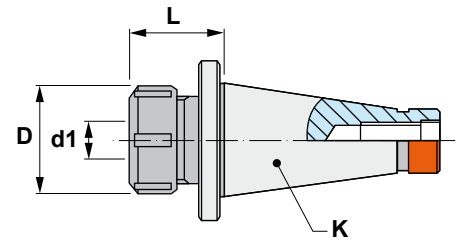





**\* SUPPLIED WITHOUT WRENCH**

Eigenschaften:  
Spannzangenfutter für Spannzangen DIN 6388.  
DIN 2080  
Für Werkzeuge mit zylindrischem Schaft DIN 1835-B.  
\* Für Kugellager-Mutter, siehe Seite: I220

**\* LIEFERUNG OHNE SCHLÜSSEL**

## 10.353

Reference Bezeichnung	K ISO	L	d1	D				
10.353.30.16	30	43	2-16	43	43316	50116	19216	0,490
10.353.30.25	30	70	3-25	60	43325	50125	19216	0,880
10.353.40.16	40	50	2-16	43	43316	50116	19216	0,970
10.353.40.25	40	63	3-25	60	43325	50125	19224	1,200
10.353.40.32	40	90	4-32	72	43332	50132	19224	1,840
10.353.50.25	50	63	3-25	60	43325	50125	19224	2,660
10.353.50.32	50	70	4-32	72	43332	50132	19230	3,330

### BXX

 I206-208

Ref. / Bez.	Accessories / Zubehör
BXX	Collets with double slot DIN 6388 - Form B Spannzangen mit Doppelnut DIN 6388 - Form B



**Characteristics:**

Collet chucks for DIN 6499 (ER) collets.  
DIN 2080  
For tools with cylindrical shank.

\* Ball bearing nut, see page: I221

**\* SUPPLIED WITHOUT WRENCH**

**Eigenschaften:**



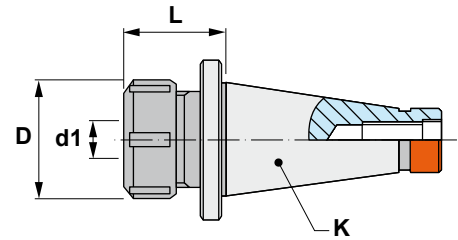

Spannzangenfutter für Spannzangen  
DIN 6499 (ER).  
DIN 2080  
Für Werkzeuge mit zylindrischem Schaft.

\* Für Kugellager-Mutter, siehe Seite: I221

**\* LIEFERUNG OHNE SCHLÜSSEL**



## 10.453

Reference Bezeichnung	K ISO		L	d1	D	D1				
10.453.30.16	30	ER16	35	0,5-10	32	-	45316	50216	19210	0,329
10.453.30.20	30	ER20	38	1-13	35	-	45320	50220	19212	0,324
10.453.30.25	30	ER25	42	1-16	42	-	45325	50225	19216	0,480
10.453.30.32	30	ER32	50	2-20	50	-	45332	50232	19218	0,520
10.453.40.25	40	ER25	44	1-16	42	-	45325	50225	19216	0,920
10.453.40.32	40	ER32	48	2-20	50	-	45332	50232	19218	0,950
10.453.40.32/070	40	ER32	70	2-20	50	-	45332	50232	19218	1,140
10.453.40.32/100	40	ER32	100	2-20	50	50	45332	50232	19218	1,506
10.453.40.32/150	40	ER32	150	2-20	50	50	45332	50232	19218	2,050
10.453.40.40	40	ER40	51	3-30	63	-	45340	50240	19224	1,070
10.453.40.40/100	40	ER40	100	3-30	63	63	45340	50240	19224	1,400
10.453.50.25	50	ER25	46	1-16	42	-	45325	50225	19216	2,870
10.453.50.25/150	50	ER25	150	1-16	42	42	45325	50225	19216	3,600
10.453.50.32	50	ER32	60	2-20	50	-	45332	50232	19218	2,960
10.453.50.32/100	50	ER32	100	2-20	50	50	45332	50232	19218	3,080
10.453.50.32/150	50	ER32	150	2-20	50	50	45332	50232	19218	3,920
10.453.50.40	50	ER40	60	3-30	63	-	45340	50240	19224	3,120
10.453.50.40/150	50	ER40	150	3-30	63	63	45340	50240	19224	4,530
10.453.50.50	50	ER50	65	6-34	78	-	45350	50250	19230	3,270

**ERXX**

 I210-212

Reference / Bezeichnung

ERXX

**40.453..**

 I180

Reference / Bezeichnung

40.453..

**ERCXX**

 I215-216

Reference / Bezeichnung

ERCXX

**40.455..**

 I181

Reference / Bezeichnung

40.455..

**ERTXX**

 I217-218

Reference / Bezeichnung

ERTXX





**Characteristics:**  
Mechanical collet chucks with high tightening torque and precision.  
DIN 2080  
For DIN 6499 (ER) collets.

The alternative to hydraulic or other systems.  
With central coolant supply.

**\* SUPPLIED WITH WRENCH**



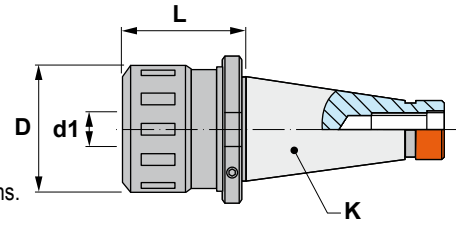

**Eigenschaften:**  
Mechanisches Spannzangenfutter mit hohem Anzugsmoment.  
DIN 2080.  
Für Spannzangen DIN 6499 (ER).

Die Alternative zu hydraulischen und anderen Systemen.  
Mit Innenkühlung.

**\* LIEFERUNG MIT SCHLÜSSEL**



## 10.457

Reference Bezeichnung	K ISO		L	d1	D				
10.457.40.32	40	ER32	80	2-20	54	45732	50704	19006	1,620
10.457.50.32	50	ER32	85	2-20	54	45732	50704	19006	3,630
10.457.50.40	50	ER40	97	3-30	65	45740	50706	19010	4,570

### ERXX

 I210-212

Ref. / Bez.      Accessories / Zubehör

ERXX      Collets with double slot DIN 6499 - Form B (ER)  
Spannzangen mit Doppelnut DIN 6499 - Form B (ER)



### ERCXX

 I215-216

Ref. / Bez.      Accessories / Zubehör

ERCXX      Sealed collets DIN 6499 (ER)  
Abgedichtete Spannzangen DIN 6499 (ER)





Characteristics:  
Blank adaptors.

Eigenschaften:  
Rohlinge mit  
weichem Schaft.

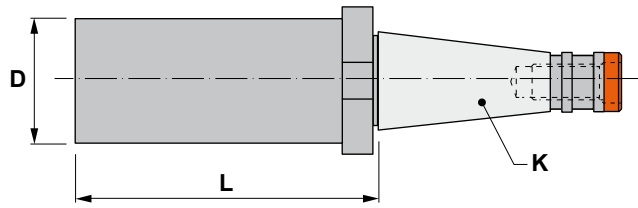

## 10.470

Reference Bezeichnung	K ISO	D	L	 Kg
10.470.40.63/250	40	63,5	250	6,760
10.470.50.95/315	50	95,5	315	18,470





**Characteristics:**

Tapping head with axial compensation.  
DIN 2080  
With DIN 6499 (ER) collets and central coolant supply.  
Compensation in compression (C) and tension (T).  
Compression can be blocked by turning the rear ring (A).  
Control of threading depth.

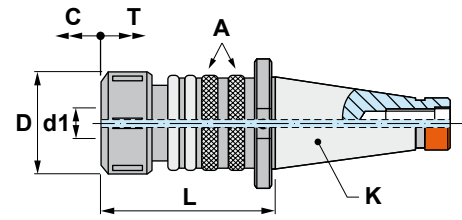

**\* SUPPLIED WITH WRENCH**

**Eigenschaften:**

Gewindeschneidfutter mit Längenausgleich DIN 2080.  
Befestigung mit Spannzangen 6499 (ER) und mit Innenkühlung.  
Ausgleich der Kompression (C) und der Traktion (T).  
Die Kompression kann mit dem Ring (A) blockiert werden.  
Kontrolle der Gewindetiefe.

**\* LIEFERUNG MIT SCHLÜSSEL**

# 10.610

Reference Bezeichnung	K ISO			d1	L	D	C	T			
10.610.30.16	30	ER16	M3-M12	100,5	28	5,5	6,0	45316	50216	0,900	
10.610.40.16	40	ER16	M3-M12	88,5	28	5,5	6,0	45316	50216	1,300	
10.610.40.25	40	ER25	M4-M20	112,0	42	10,5	7,5	45325	50225	1,850	
10.610.40.40	40	ER40	M8-M33	128,0	63	10,0	10,0	45340	50240	3,050	
10.610.50.16	50	ER16	M3-M12	82,5	28	5,5	6,0	45316	50216	3,100	
10.610.50.25	50	ER25	M4-M20	106,0	42	10,5	7,5	45325	50225	3,650	
10.610.50.40	50	ER40	M8-M33	122,0	63	10,0	10,0	45340	50240	4,850	

## ERXX

I210-212

Ref. / Bez.      Accessories / Zubehör

ERXX      Collets with double slot DIN 6499 - Form B (ER)  
Spannzangen mit Doppelnut DIN 6499 - Form B (ER)



## ERCXX

I215-216

Ref. / Bez.      Accessories / Zubehör

ERCXX      Sealed collets DIN 6499 (ER)  
Abgedichtete Spannzangen DIN 6499 (ER)



## ERTXX

I217-218

Ref. / Bez.      Accessories / Zubehör

ERTXX      Collets DIN 6499 - Form Mexin (ER)  
Spannzangen DIN 6499 - Form Mexin (ER)



## 40.453..

I180

Ref. / Bez.      Accessories / Zubehör

40.453..      Collet chucks for DIN 6499 (ER) collets  
Spannzangenfutter für DIN 6499 (ER) Spannzangen



## 40.455..

I181

Ref. / Bez.      Accessories / Zubehör

40.455..      Long collet chucks for DIN 6499 (ER) collets  
Lange Spannzangenfutter für DIN 6499 (ER) Spannzangen



**Characteristics:**

Quick change tapping head with axial compensation. DIN 2080  
With Bilz system tap chucks bushings.

Compensation in compression (C) and tension (T).



**Eigenschaften:**

Gewindeschneid-Schnellwechselfutter mit Längenausgleich. DIN 2080  
Mit Schnellwechseleinsätzen Bilz-System.

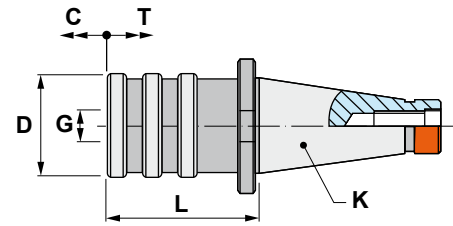
Ausgleich der Kompression (C) und der Traktion (T).



## 10.620

Reference Bezeichnung	K ISO	N <sup>G</sup> Ø	d1	L	D	C	T			
10.620.30.12	30	1 19	M3-M12	41	38	9	9	710XX	750XX	0,580
10.620.40.12	40	1 19	M3-M12	52	38	9	9	710XX	750XX	1,070
10.620.40.20	40	2 31	M8-M20	77	55	15	15	720XX	760XX	1,460
10.620.40.33	40	3 48	M14-M33	97	79	24	24	730XX	770XX	3,500
10.620.50.12	50	1 19	M3-M12	41	38	9	9	710XX	750XX	4,600
10.620.50.20	50	2 31	M8-M20	79	55	15	15	720XX	760XX	4,600
10.620.50.33	50	3 48	M14-M33	125	79	24	24	730XX	770XX	5,090

### 710XX..730XX

 I202

Ref. / Bez.

Accessories / Zubehör

710XX..730XX

Quick change adapters without overload clutch  
Schnellwechseleinsätze ohne Sicherheitskupplung



### 750XX..770XX

 I203

Ref. / Bez.

Accessories / Zubehör

750XX..770XX

Quick change adapters with overload clutch  
Schnellwechseleinsätze mit Sicherheitskupplung





**1 TYPE / TYP**

10.160	10.165	10.180	10.210	10.215
10.216	10.220	10.225	10.290	10.295
10.296	10.300	10.302	10.353	10.453
10.457	10.470	10.610	10.620	

**2 DIMENSION / ABMESSUNGEN**

<b>30</b>	<b>40</b>	<b>50</b>	<b>60</b>
-----------	-----------	-----------	-----------

**3 LENGTH / LÄNGE (L)**

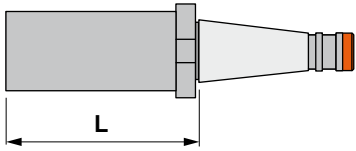
	<hr/> <hr/> <hr/> <hr/> <hr/>
---	-------------------------------

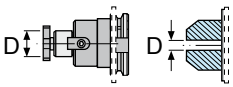
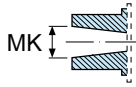
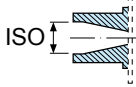
<p>Ø DIAMETER / DURCHMESSER</p> 	<p>MK</p> 	<p>ISO</p> 	<p>COLLET SPANNZANGEN</p>

**NOTES / BEMERKUNGEN:** \_\_\_\_\_

\_\_\_\_\_

\_\_\_\_\_

\_\_\_\_\_

\_\_\_\_\_